



# MICHIGAN'S 2017 Roads & Bridges ANNUAL REPORT



Michigan  
Transportation Asset  
Management Council

## Transportation Asset Management Council



**The Michigan Transportation Asset Management Council acts as a resource for independent objective data on the condition of Michigan's roads and bridges and a resource for implementing the concepts of asset management.**

# TRANSPORTATION ASSET MANAGEMENT COUNCIL (TAMC)

## TAMC members for 2017 and the organizations they represent:

**Joanna Johnson (TAMC Chair)**, County Road Association of Michigan (CRA)

**William McEntee (TAMC Vice-Chair)**, CRA

**Derek Bradshaw**, Michigan Association of Regions (MAR)

**Don Disselkoen**, Michigan Association of Counties (MAC)

**Gary Mekjian, P.E.**, Michigan Municipal League (MML)

**Bob D. Slattery Jr.**, MML

**Jonathan R. Start**, Michigan Transportation Planning Association (MTPA)

**Rob Surber**, Michigan Center for Shared Solutions (Non-Voting)

**Jennifer Tubbs**, Michigan Townships Association (MTA)

**Brad Wieferich**, Michigan Department of Transportation (MDOT)

**Dave Wresinski**, MDOT

For added background on the TAMC, its members and its related legislation, please visit the *About Us* section on the TAMC website at:

**[www.michigan.gov/tamc](http://www.michigan.gov/tamc)**

## Support Excellence in Managing Michigan's Transportation Assets:

- Advise Michigan Legislature and State Transportation Commission
- Promote asset management principles
- Provide tools and practices for road agencies



## Team Members

**Roger Belknap**

**Tim Colling**

**Charlie Jarvis**

**Polly Kent**

**Gil Chesbro**

**Clint Crick**

**Dave Jennett**

**Josh Ross**

**John Clark**

**Beckie Curtis**

**Jeri Kaminski**

**Gloria Strong**

# INTRODUCTION

2017 was a very active year, from collection of Road and Bridge conditions to new efforts tied to the Michigan Infrastructure Asset Management Pilot Program, as well as pilots for asset management plan development, and upgrades to many services such as the Investment Reporting Tool and interactive map.

## Major takeaways from 2017:

- **Roads** – Poor pavements continue to increase. The number of miles of Federal Aid Roads in poor condition is now equal to the number of miles in fair condition. *(See 2017 Road Condition)*
- **Bridges** – Nearly twice as many bridges declined in condition compared to those that were improved. *(See 2017 Bridge Condition)*

## Encouraging news:

- **Investment Data** – The first full year of investment data is now available to assist in future data-driven decision-making. *(See Investment Reporting)*
- **Pilot Programs** – New tools and classes are being created to develop asset management plans and expand asset inventory collection efforts *(See TAMC 2017 Year in Review)*

## Paved Federal-Aid Road Condition

2007-2017

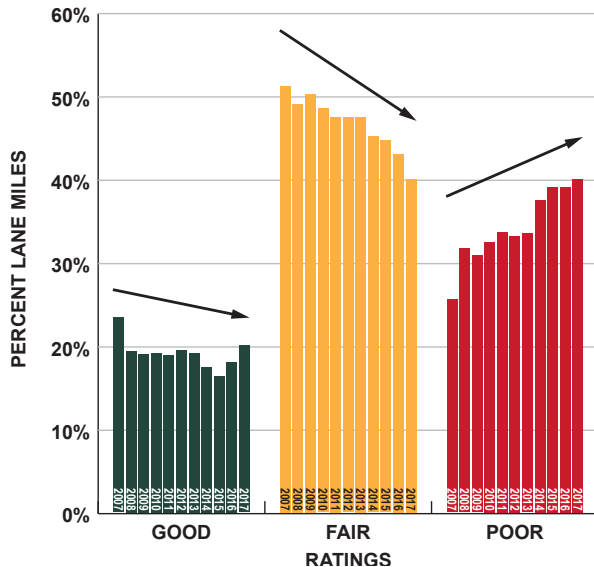

## Michigan Bridges Cycle of Life

2014-2017

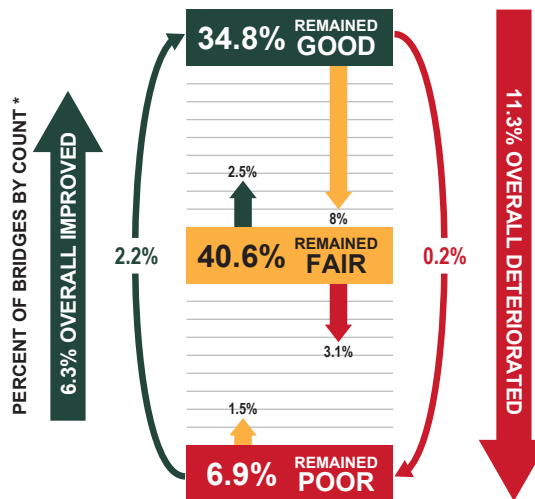

\* Does not include bridges added or removed in this time period

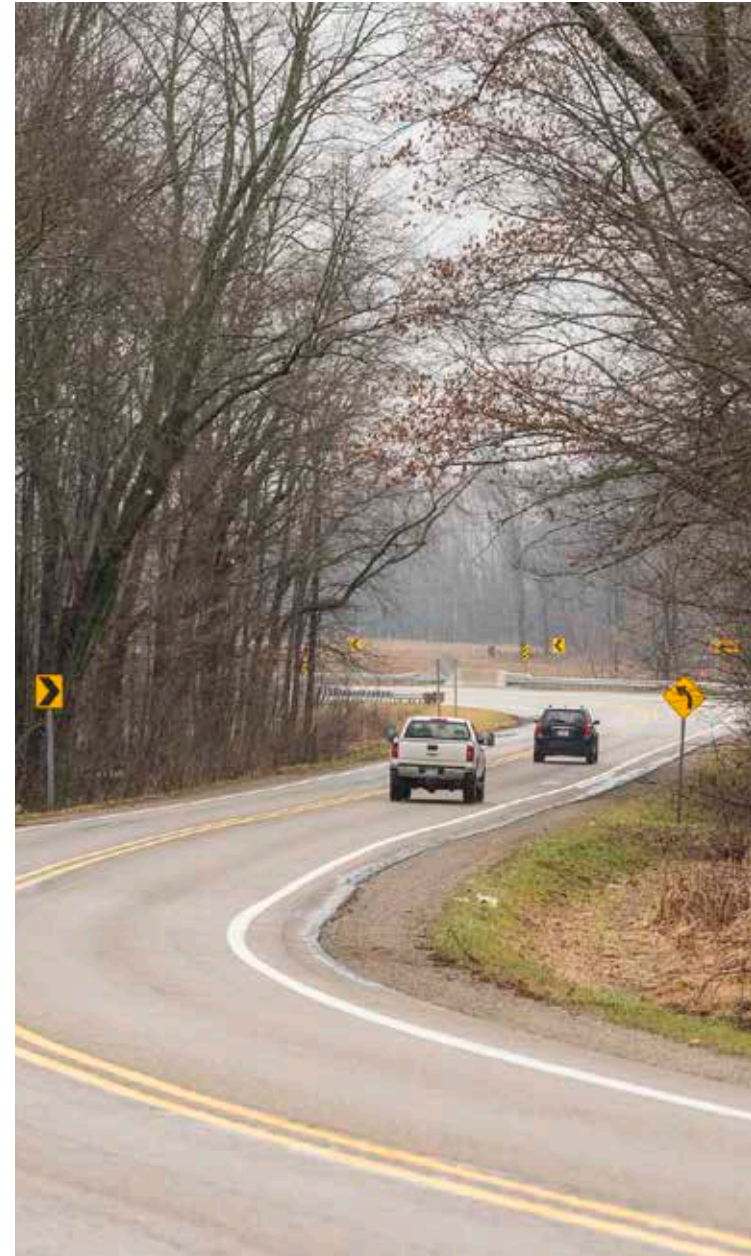

# TABLE OF CONTENTS



<b>2017 Road Condition</b> .....	<b>1</b>
Analysis of Paved Federal-Aid Roads	
Pavement Cycle of Life	
Functional Class	
Quality Management	
Analysis of Paved Non-Federal-Aid Roads	
Condition Forecast	
<b>2017 Bridge Condition</b> .....	<b>13</b>
Bridge Condition Forecast	
Bridge Cycle of Life	
<b>2017 Year in Review</b> .....	<b>23</b>
TAMC Accomplishments	
TAMC Website, Interactive Map and Dashboards	
<b>Investment Reporting</b> .....	<b>33</b>
Act 51 Compliance Reporting	
Road Projects Details	
Bridge Projects Details	
Preliminary Analysis: Defining a Statewide Asset Management Strategy	
Saving the 5's	
Asset Management Plans and Process Survey	
Planning Agency Involvement	
<b>Looking Ahead to 2018</b> .....	<b>41</b>
<b>Acronyms and Abbreviations</b> .....	<b>45</b>

# 2017 ROAD CONDITION



Over the past 15 years, Michigan's paved federal-aid roads have steadily deteriorated (see Figure 1). As of 2017, over 35,000 lane miles are in poor condition, or 40% of all paved federal-aid roads. Eleven years ago, 25% were in poor condition. Given the current rate of road deterioration and given the anticipated funding levels for road preservation and repair, the percentage of roads in poor condition will not decrease till 2025, at which time 38% are predicted to be in poor condition.

# Paved Federal-Aid Road Condition

2007-2017

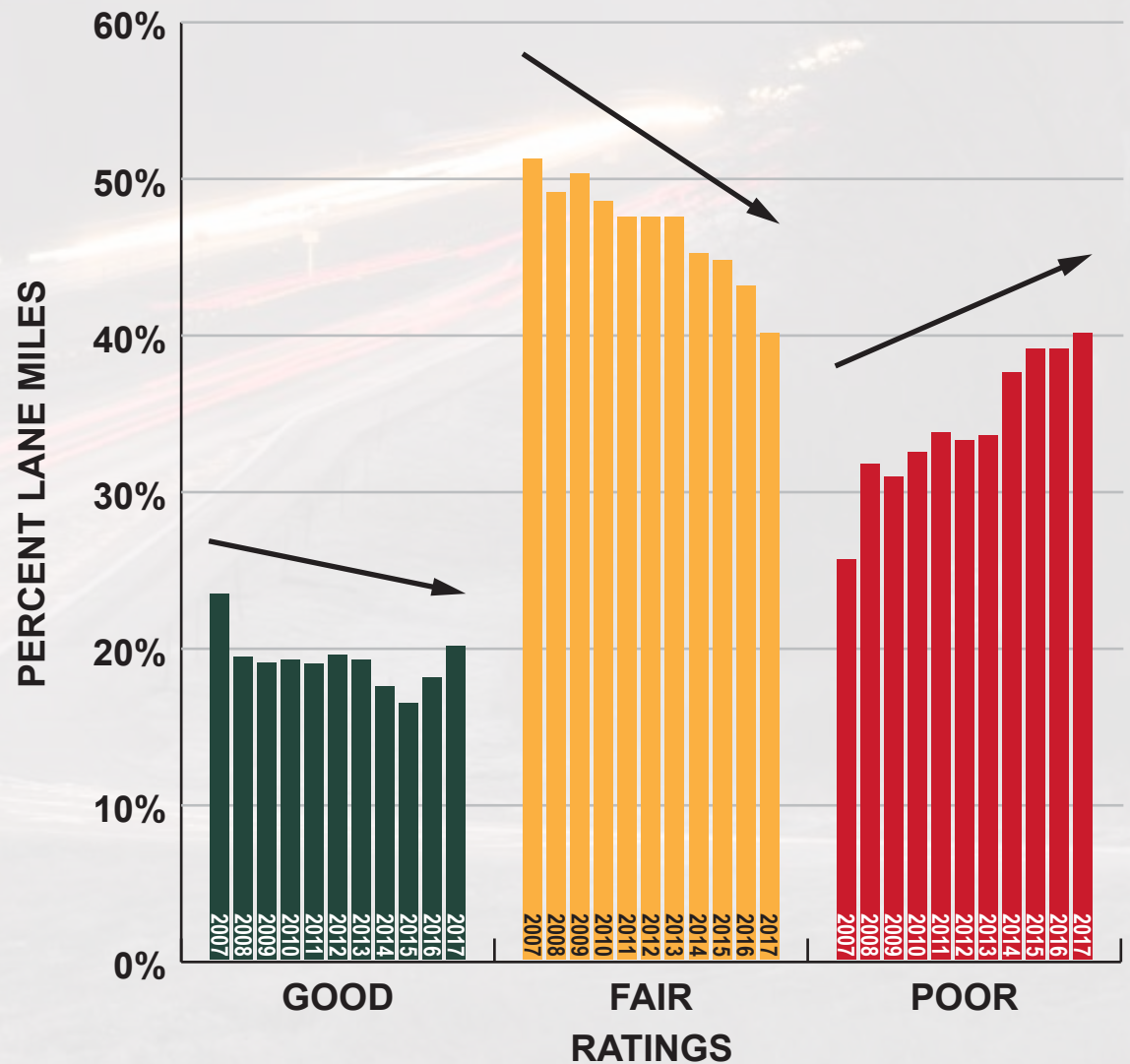

Figure 1  
Source: 2007-2017 PASER Data Collection



In 2003, MDOT, county, regional, and metropolitan planning agencies joined together to determine the condition of Michigan's paved federal-aid roads. Only about  $\frac{1}{3}$  of Michigan's roads are eligible for federal aid. Not all eligible roads are paved. Under the direction of the TAMC, PASER (Pavement Surface Evaluation and Rating) was the tool chosen to measure the condition of pavements. Road raters

evaluated surface condition and placed each segment of road into one of ten categories which were then consolidated into three categories: good, fair, and poor. Agencies drove the roads in the late spring, summer and fall months. By mid-December, their rating data were loaded into a central database. What follows is an analysis of those data.



# Analysis of Paved Federal-Aid Roads

Road agencies report on the condition of all paved federal-aid roads over the course of two years. Some agencies rate and report 50% of roads each year; some report on 100% every other year; and some chose to report on all their roads every year. Figure 2 is a map showing roads that were rated in 2016 and 2017. About 63% of the roughly 88,000 lane miles of paved federal-aid roads were rated in 2017. For the full statewide coverage, the remaining 37% was taken from ratings performed in 2016.

# Paved Federal-Aid Roads

Rated in 2016 and 2017

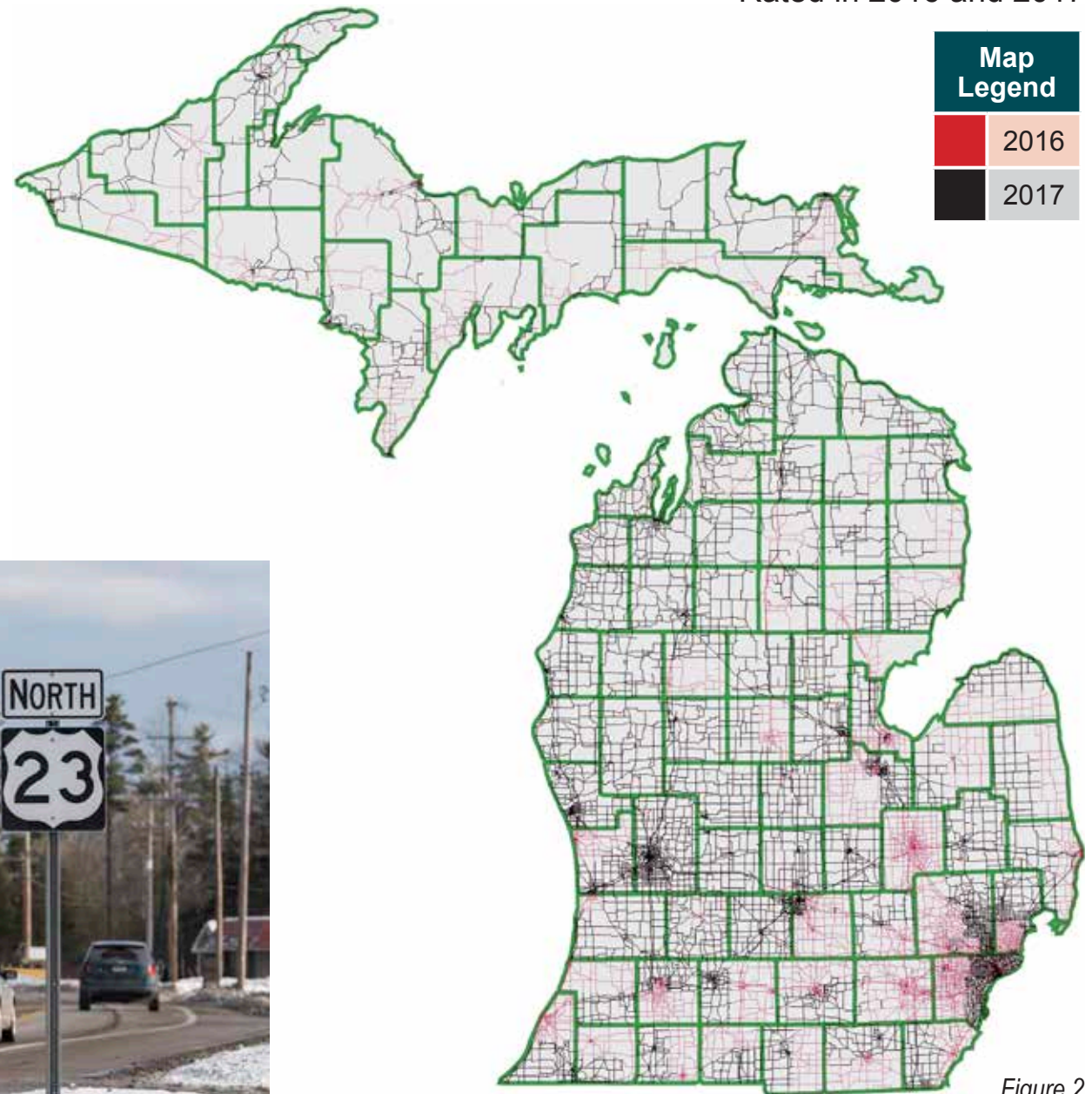

Figure 2

Source: 2016-2017 PASER Data Collection



# 2016/17 vs 2014/15 Paved Federal-Aid Road Condition

Percent Lane Miles

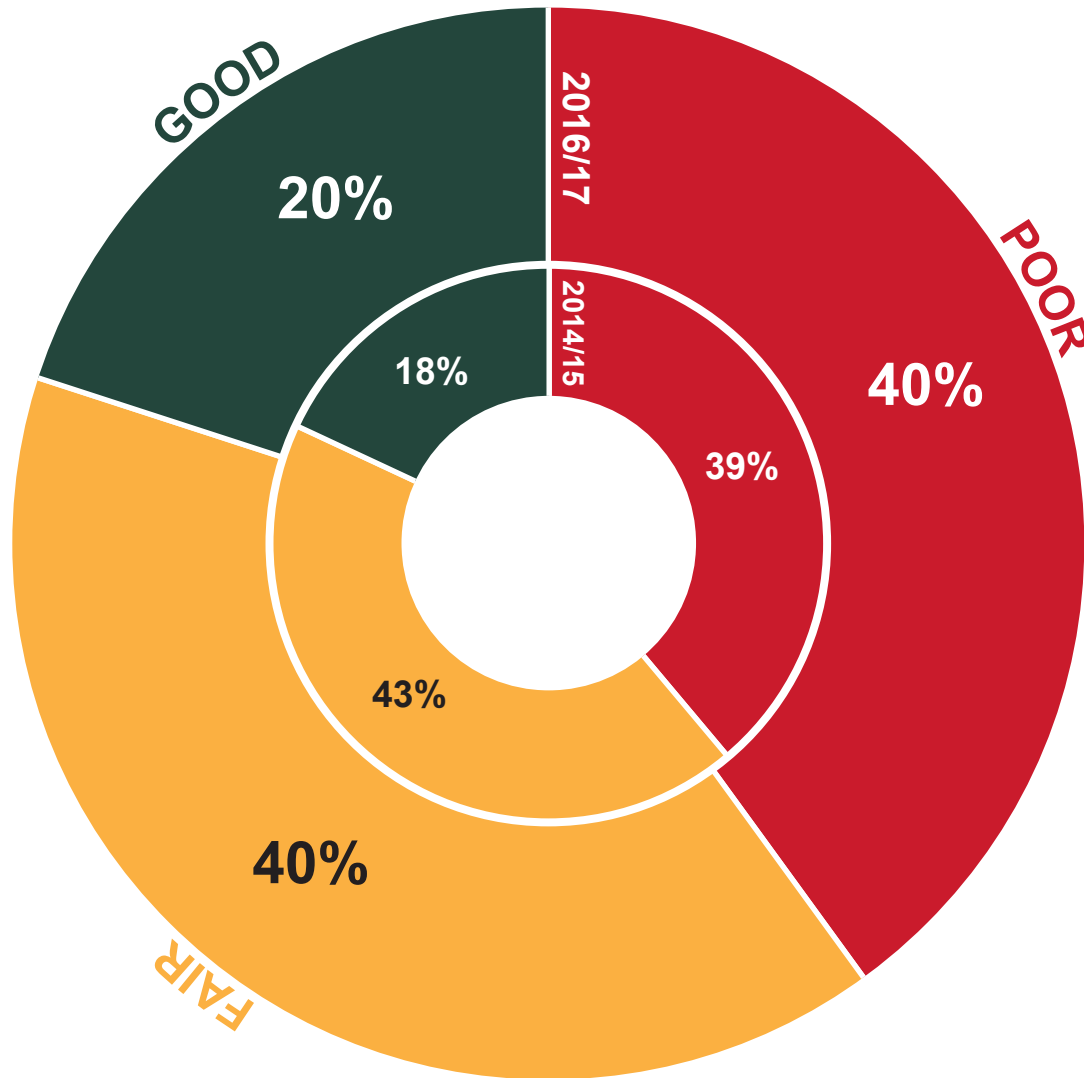

Figure 3

Source: 2014-2017 PASER Data Collection

As seen in Figure 3, the number of lane miles in good and fair condition decreased from 61% to 60% between 2014/15 and 2016/17. This 1% decline represents an additional 880 lane miles that are now in poor condition.



# Pavement Cycle of Life

Every year, analysts examine the pavement data to determine the extent to which roads are improved or deteriorate over time. Figure 4, known as the "Pavement Cycle of Life," shows the results of this analysis. For well over a decade, more roads have deteriorated than have been improved. This has happened every year since 2005, and 2017 was not an exception. This trend must be reversed if Michigan's roads are to improve.



# Michigan Pavement Cycle of Life

2014-2017

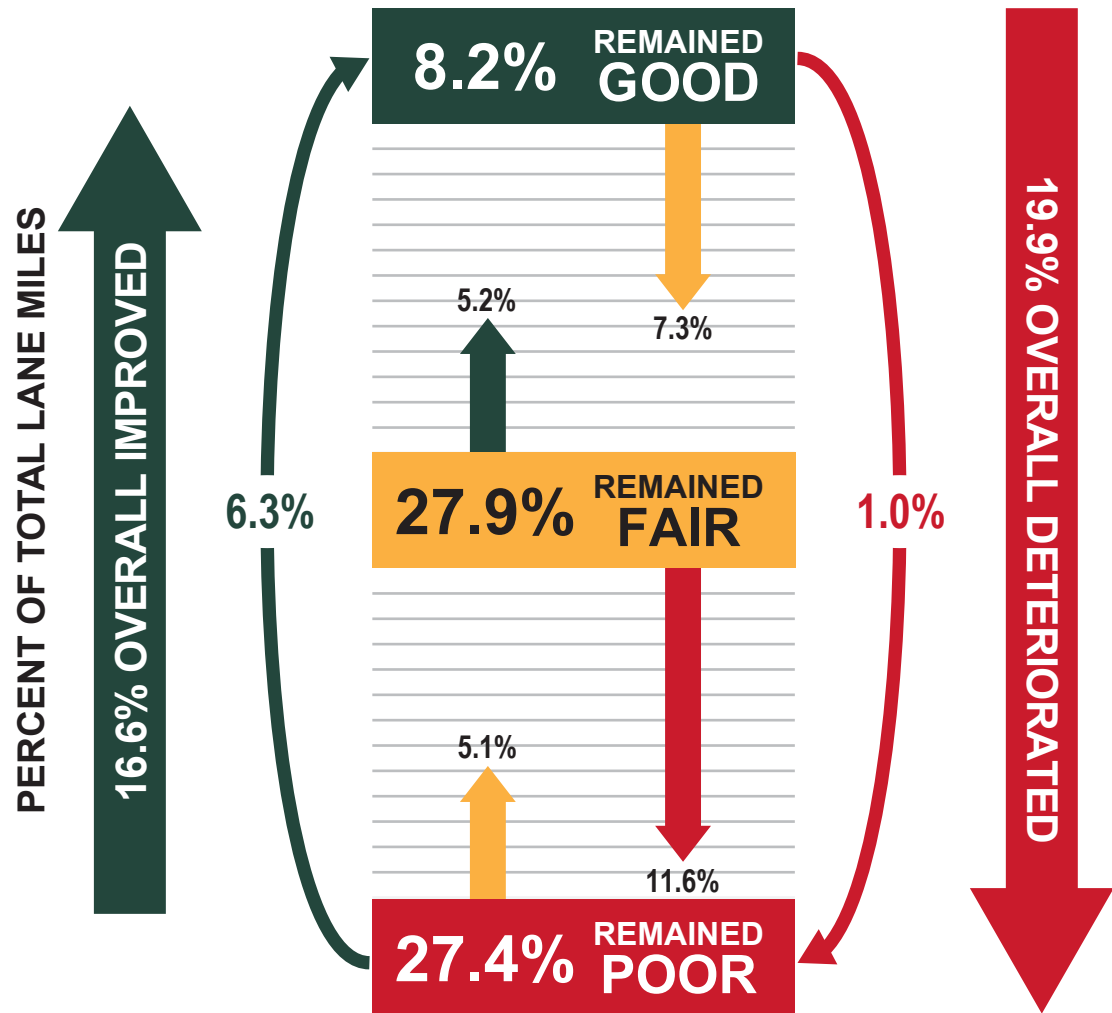

Figure 4  
Source: 2014-2017 PASER Data Collection

# Paved Federal-Aid Roads

By Functional Class

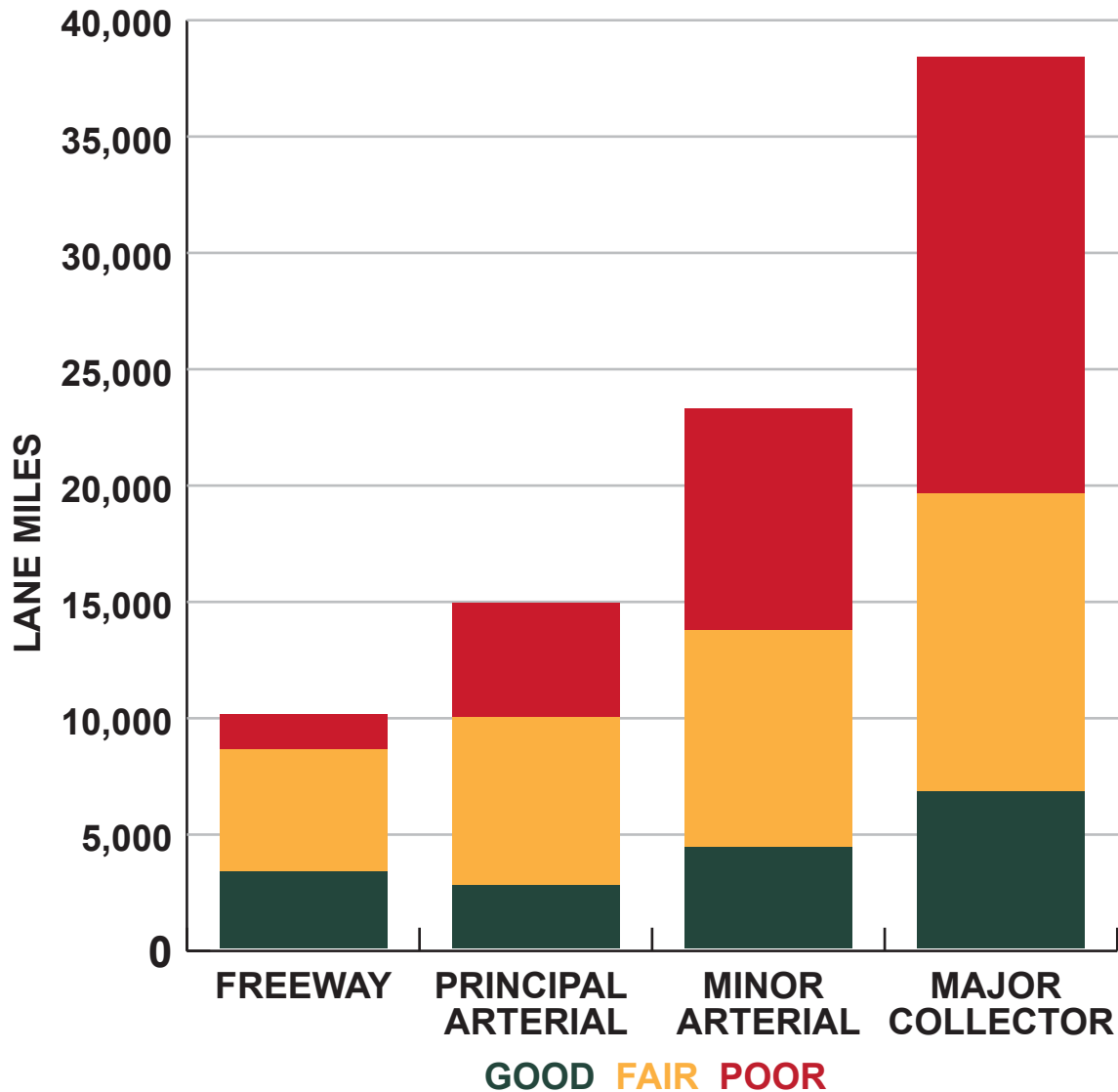

Figure 5

Source: 2016-2017 PASER Data Collection

# Functional Class

Functional classes are federally defined categories used to describe the “particular role of a roadway.” Freeways, arterials, minor arterials, and major collectors are all federal-aid eligible roads. Freeways carry the highest volume of passenger and commercial traffic. Arterials also carry large volumes of traffic and, together with freeways, comprise the federal National Highway System in Michigan. Minor arterials and major collectors primarily serve to connect traffic from local roads to the arterial and freeway systems. Figure 5 shows the condition of paved federal-aid roads in each category. As the exhibit shows, there is a direct correlation between category and condition, as agencies work to keep the most highly used roads in the best condition.



# Quality Management

Quality management of road rating data is conducted every fall. A single pavement technician surveys 1,200 lane miles of paved federal-aid roads and assigns PASER ratings to them. These roads act as samples. Every county in the state contains sample miles. At the close of each year, these samples are compared to the road agencies' ratings. The results of this comparison are shown as a bell curve, seen in Figure 6. On average, the road agencies rated their sample roads about  $\frac{1}{3}$  of a rating higher than the pavement technician did. Much of this small difference can be attributed to the road agencies rating the samples in the fall, near the end of the construction season, after some of the sample roads have been improved.



## 2017 Team Ratings Minus Quality Ratings Weighted by Lane Miles

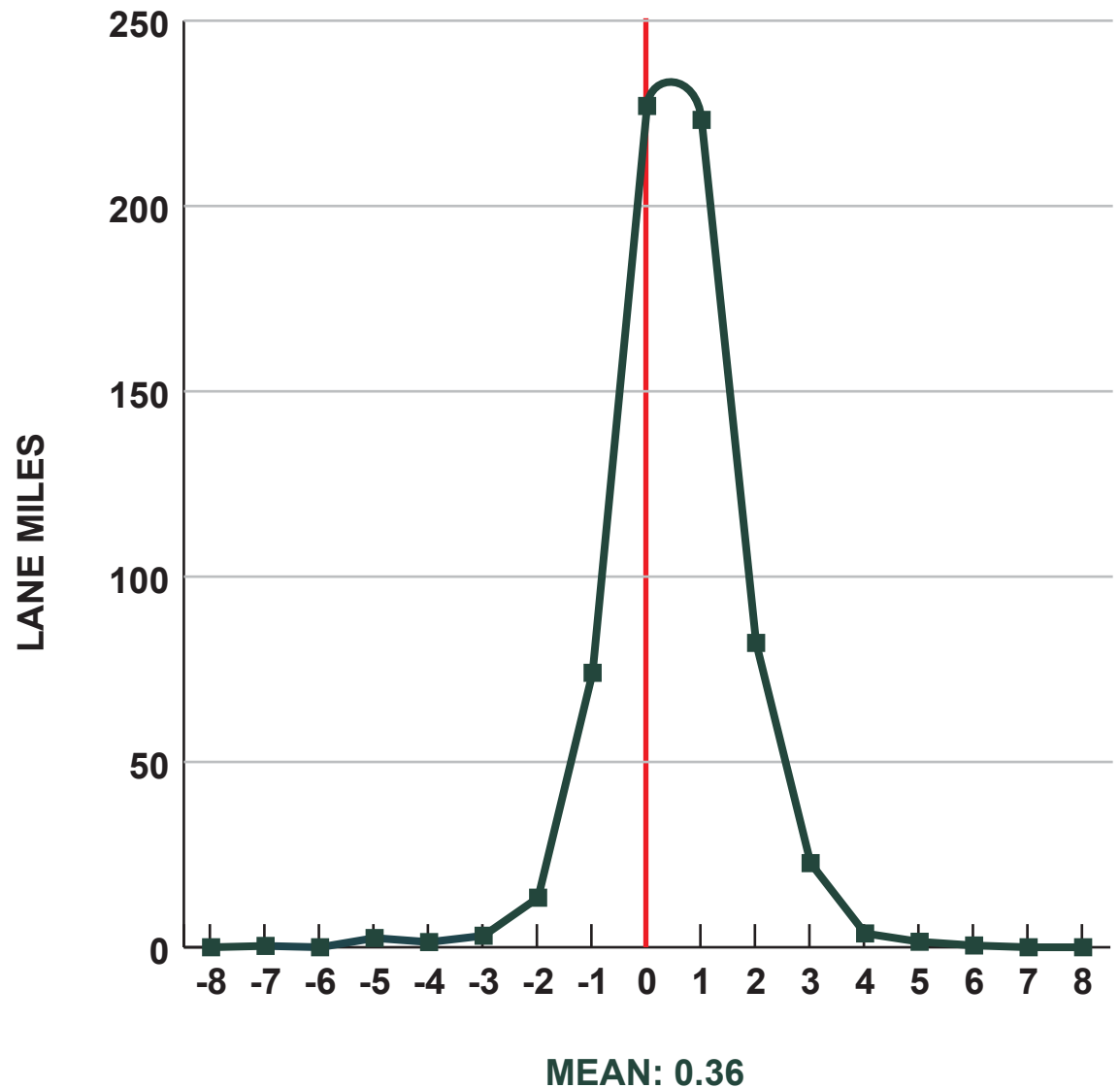

Figure 6  
Source: 2017 PASER Data Collection

# 2017 Paved Non-Federal-Aid Road Condition

Percent Lane Miles

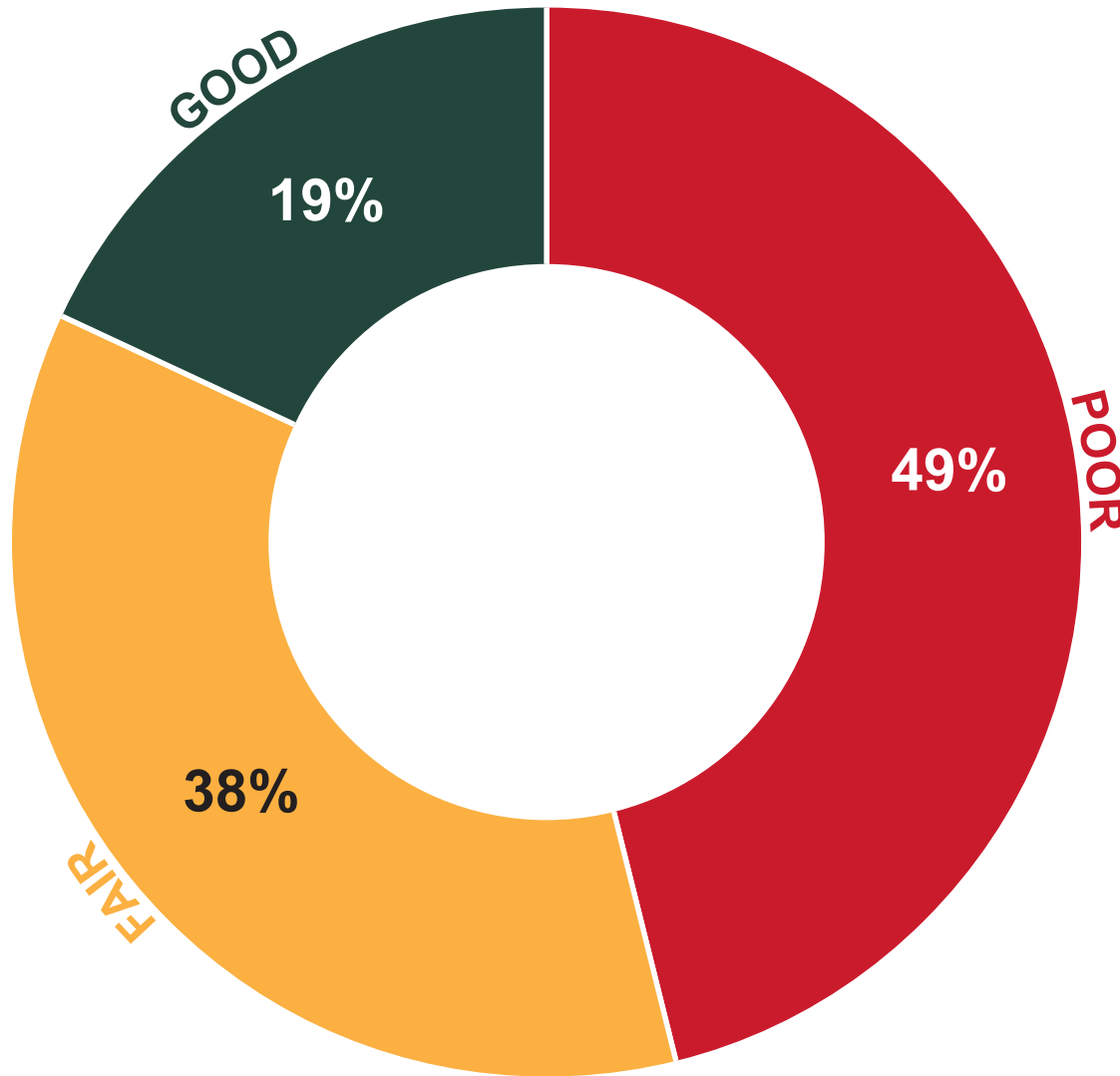
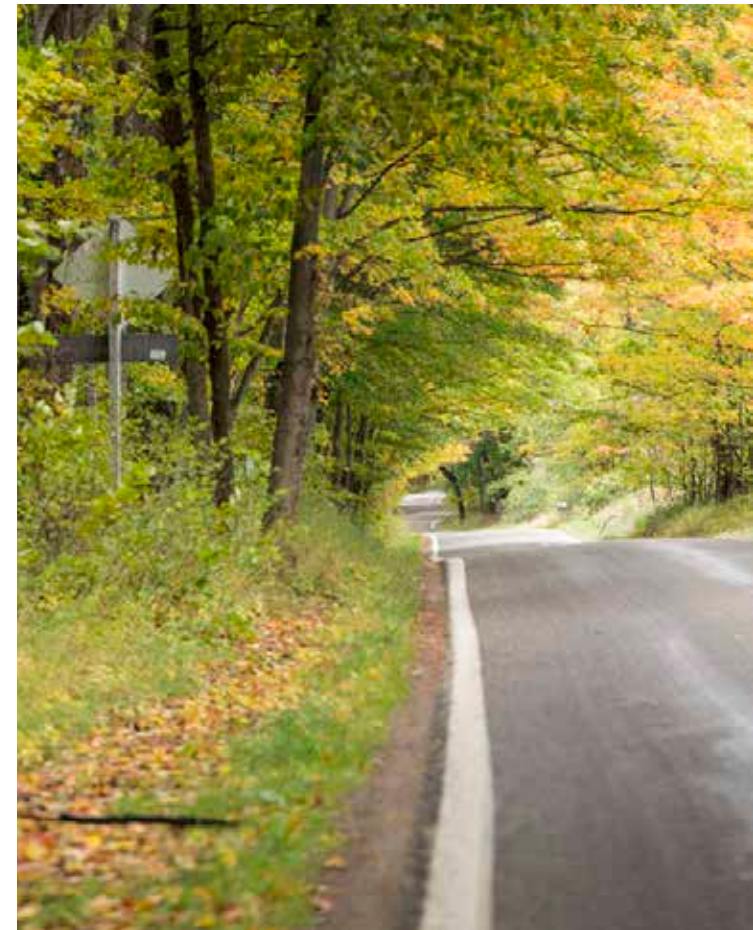

Figure 7

Source: 2017 PASER Data Collection

# Analysis of Paved Non-Federal-Aid Roads

There are over 165,000 lane miles of non-federal-aid roads in Michigan. The federal government classifies these roads as being “Local Roads.” Each year, several road agencies choose to rate some or all of their paved non-federal-aid roads. Figure 8 shows in 2017, 71 agencies submitted ratings for 17,092



# Paved Non-Federal-Aid Roads

Rated in 2017 – 17,092 Lane Miles

lane miles of these roads. Almost 50% of these roads were found to be in poor condition as seen in Figure 7. Although it is not known if the roads that were rated represent a valid statistical sample, it is probably safe to assume that, as a class, non-federal-aid roads are in worse condition than federal-aid roads.

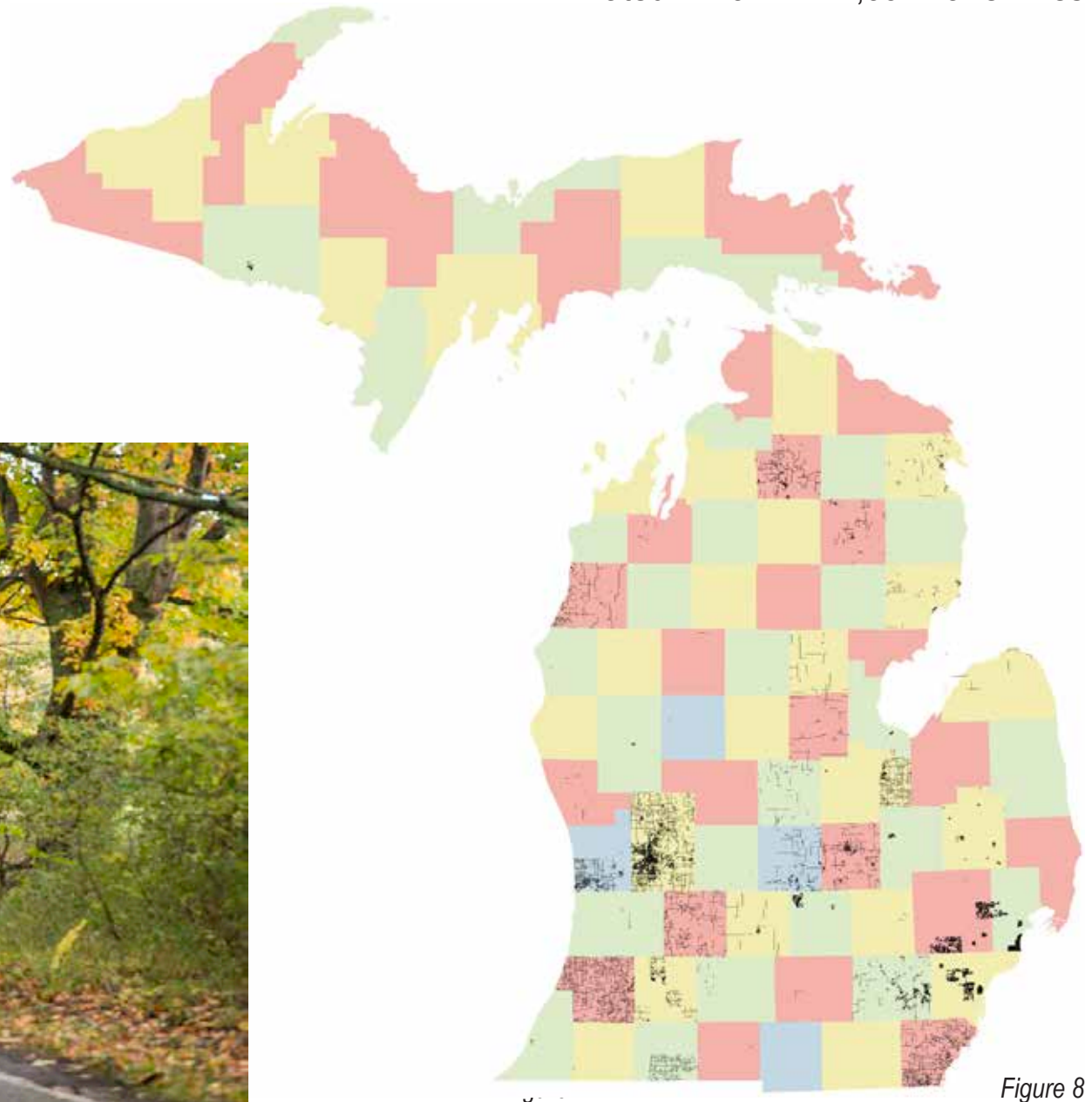
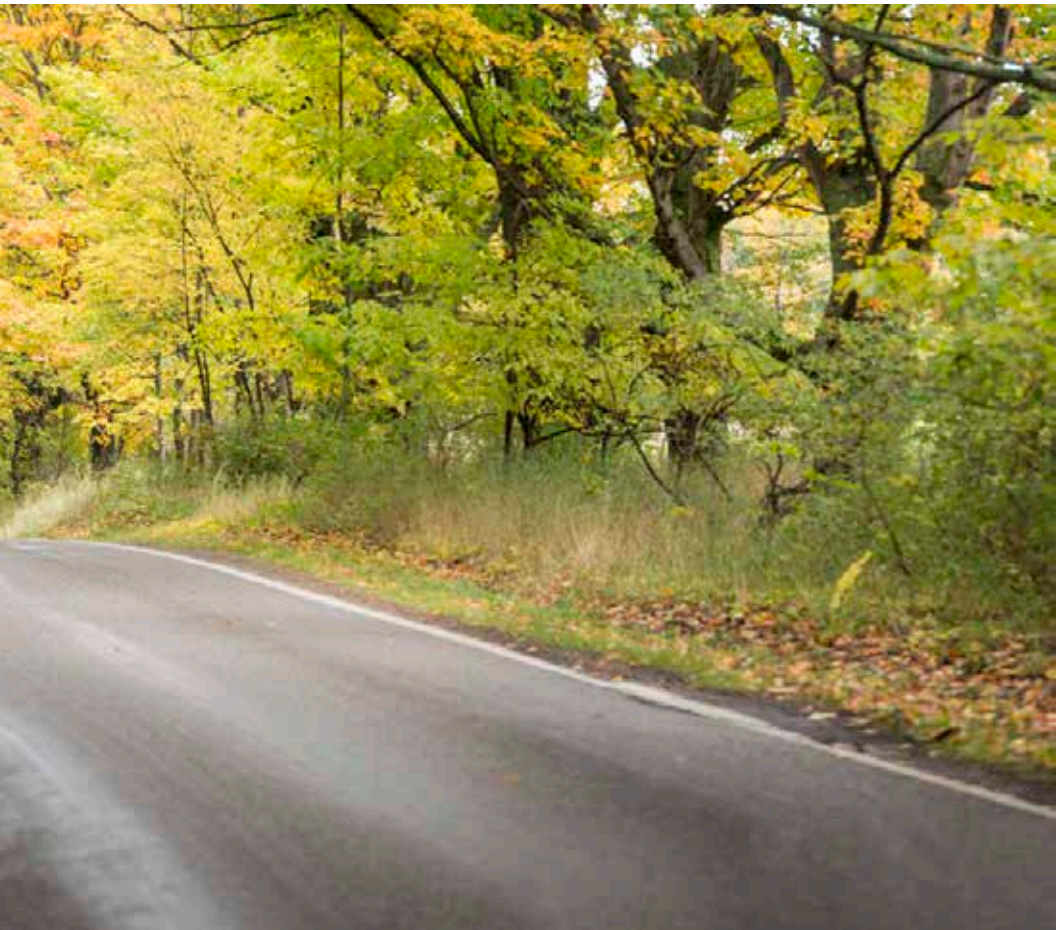

Figure 8  
Source: 2017 PASER Data Collection

# 2019-2029 Forecast of Pavement Condition

All Paved Federal-Aid Roads

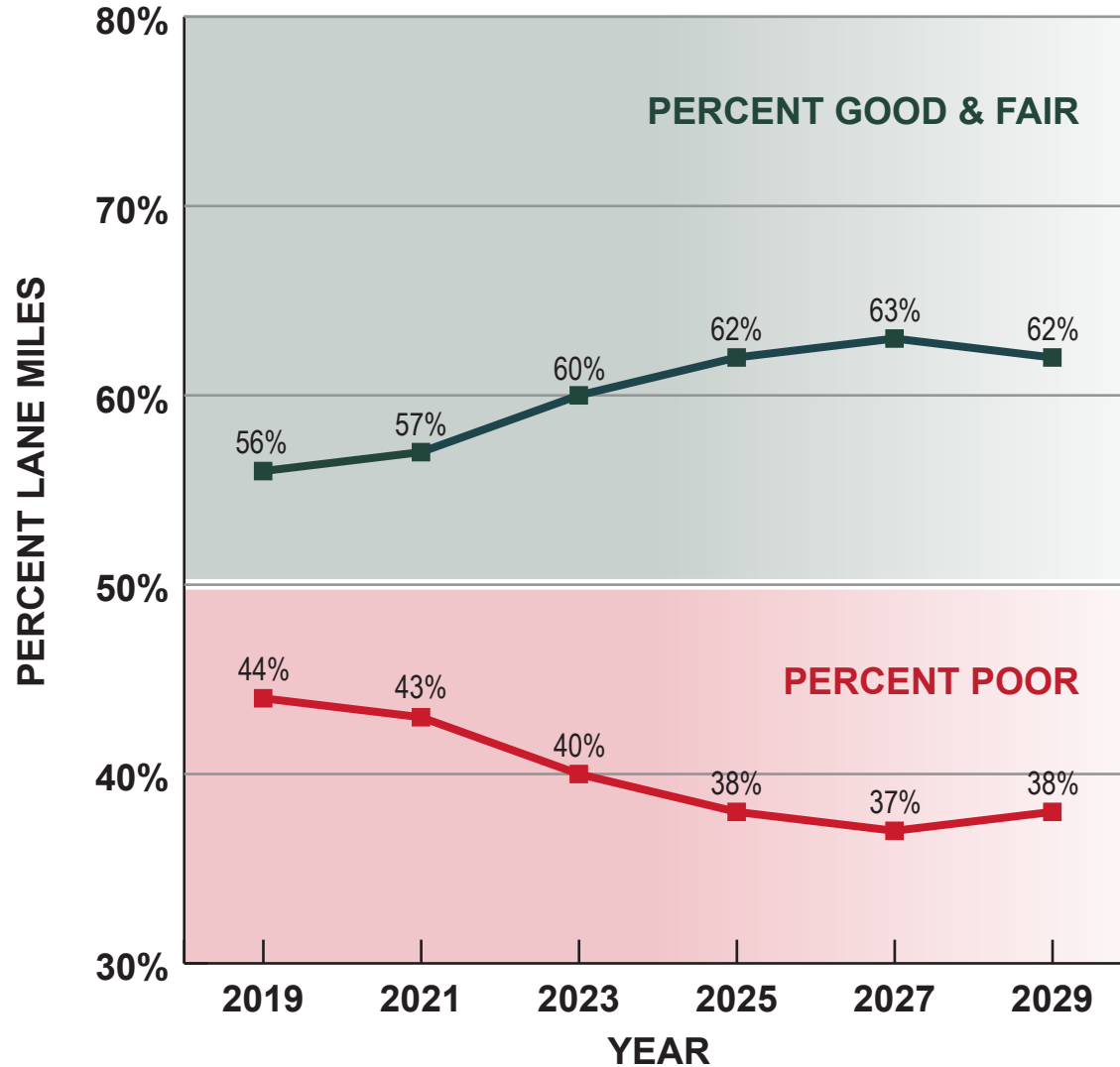
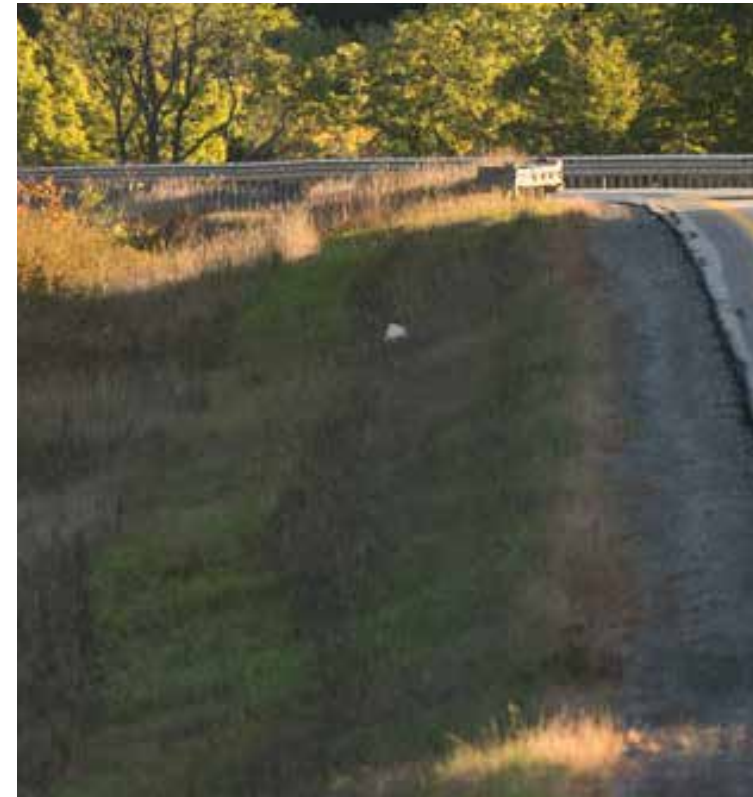

Figure 9  
Source: TAMC March 2018

## Condition Forecast

Marginal improvement in the condition of paved federal-aid roads can be expected over the next 11 years as seen in Figure 9. In November of 2015, the Michigan legislature passed a transportation funding package that will incrementally increase road funding. The additional funding began in 2017. The increases will continue until 2021 and then increase with inflation. A portion of that funding will come from Michigan income taxes. The small improvements shown in Figure 9 are due to the expected increase in funding. Any future changes in funding will affect the forecast.







# 2017 BRIDGE CONDITION



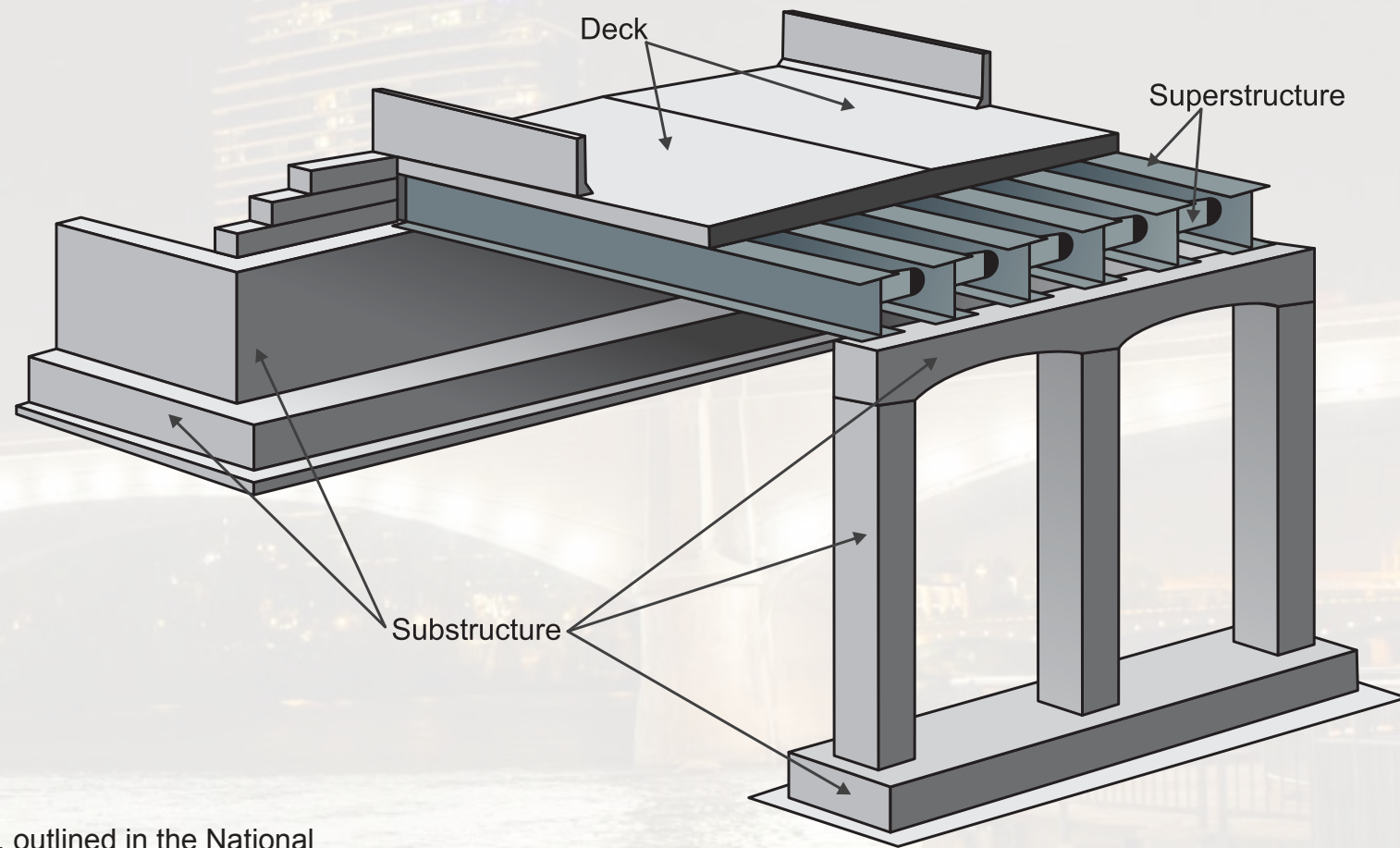

Federal law, outlined in the National Bridge Inspection Standards (NBIS), defines a bridge as a structure carrying traffic with a span greater than 20 feet and requires that all bridges be inspected every two years to monitor and report condition ratings. The FHWA requires that for each applicable bridge, the performance measures for determining condition be based on the minimum values for substructure, superstructure,

deck, and culverts. The FHWA further requires counting this condition by the respective deck area of each bridge and expressing condition totals as a percentage of the total deck area of bridges in a state.

Condition ratings are based on a 0-9 scale and assigned for each culvert, or the deck, superstructure and substructure of each bridge. These ratings are recorded in the National Bridge Inventory (NBI) database. Condition ratings are an important tool for transportation asset management, as they are used to identify preventative maintenance needs, and to determine rehabilitation and replacement projects that require funding.

An analysis of bridge conditions in Michigan shows that bridge-owning agencies and decision makers are continuing to “hold their own” despite rising costs and revenue challenges. From 2004 to 2017, the network of bridges in the state saw a slight but steady improvement in overall condition.

However, from 2011 to 2017 the improvement in bridge condition has stagnated with a slight decline in 2017, and the current forecast shows a gradual decline as the forecast approaches the year 2027. This can be attributed to:

1. Progress being made initially in reducing the number of structurally deficient bridges in the state.
2. More bridge owning agencies are implementing preventive maintenance “mix of fixes” strategies on bridges that they own.
3. Rising costs and an increasing inventory of fair bridges creates a preservation need that exceeds available funding.

The percentage of Michigan’s bridges which are rated structurally deficient is one of the state’s measures of the overall strength of Michigan’s economy, and this measure can be accessed here:

<https://future.michigan.gov/stat/goals/pm2b-qqpn/2yeu-g8wn/97mf-mai3>

NBI Condition Ratings		
7-9	Good Condition	Routine maintenance candidate.
5-6	Fair Condition	Preventative maintenance and minor rehabilitation candidate.
4	Poor Condition	Poor Major rehabilitation or replacement candidate.
2-3		Serious or Critical Emergency repair or high priority major rehabilitation or replacement candidate. Unless closely monitored it may be necessary to close until corrective action can be taken.
0-1		Imminent Failure or Failed Major rehabilitation or replacement candidate. Bridge is closed to traffic.



Comparing Michigan's progress toward reducing poor bridges with the rest of the nation and with our neighboring states highlights the need for continued concern regarding Michigan's ability to preserve its strategic bridge assets. Figure 10 indicates that Michigan has a significantly higher percentage of poor bridges than other Great-Lakes states. An analysis of the 2017 NBI data shows that 4.9 percent of MDOT bridges and 13.7 percent of county, city and village bridges were structurally deficient, resulting in Michigan having 10.3 percent of all highway bridges structurally deficient.



# 2017 Percent Poor Bridges

All Highway Bridges (Great Lakes States)

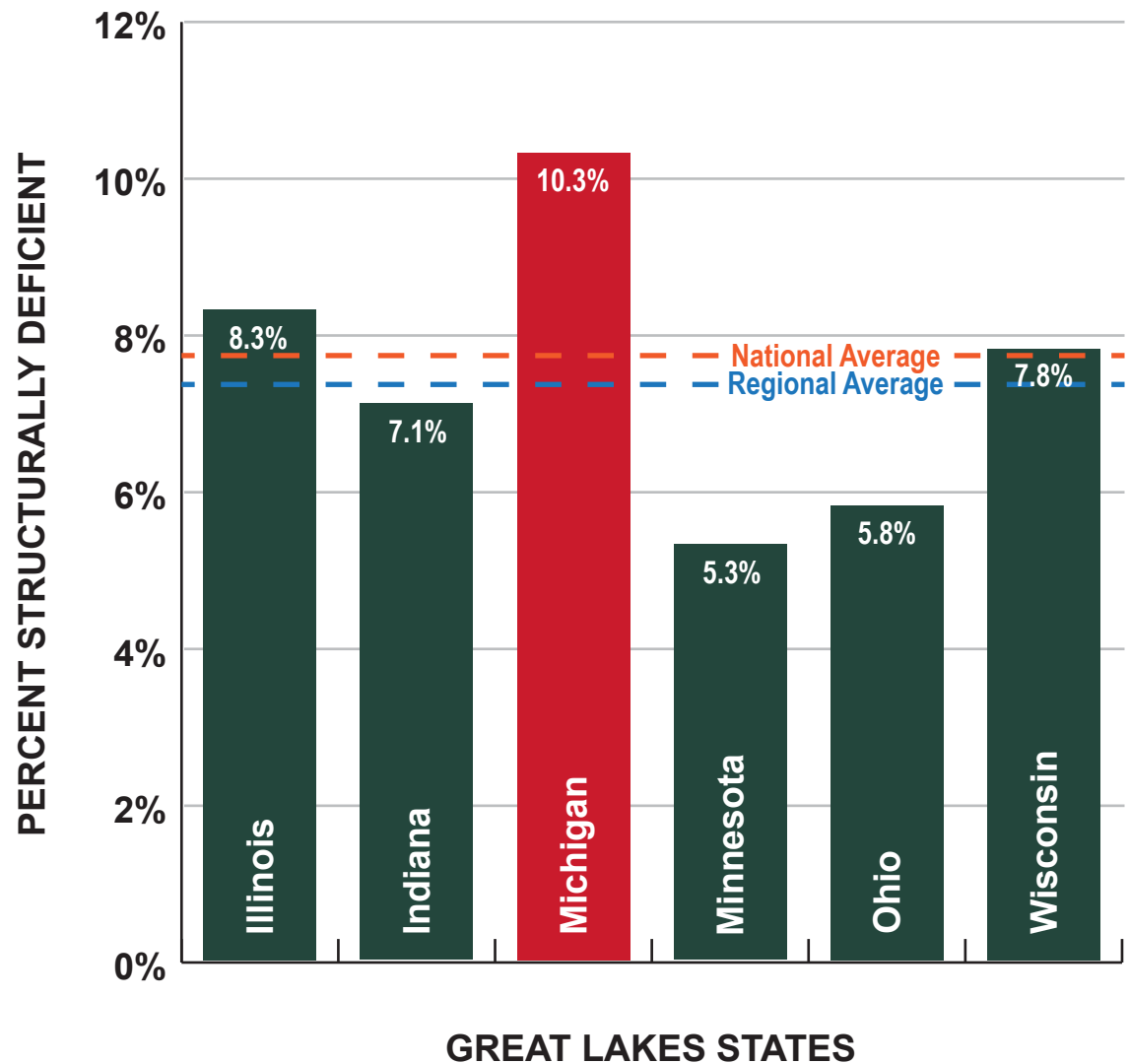

Figure 10  
Source: MDOT March 2018

# 2010-2017 Bridge Condition

All Roadway Bridges (MDOT and Local Agency)

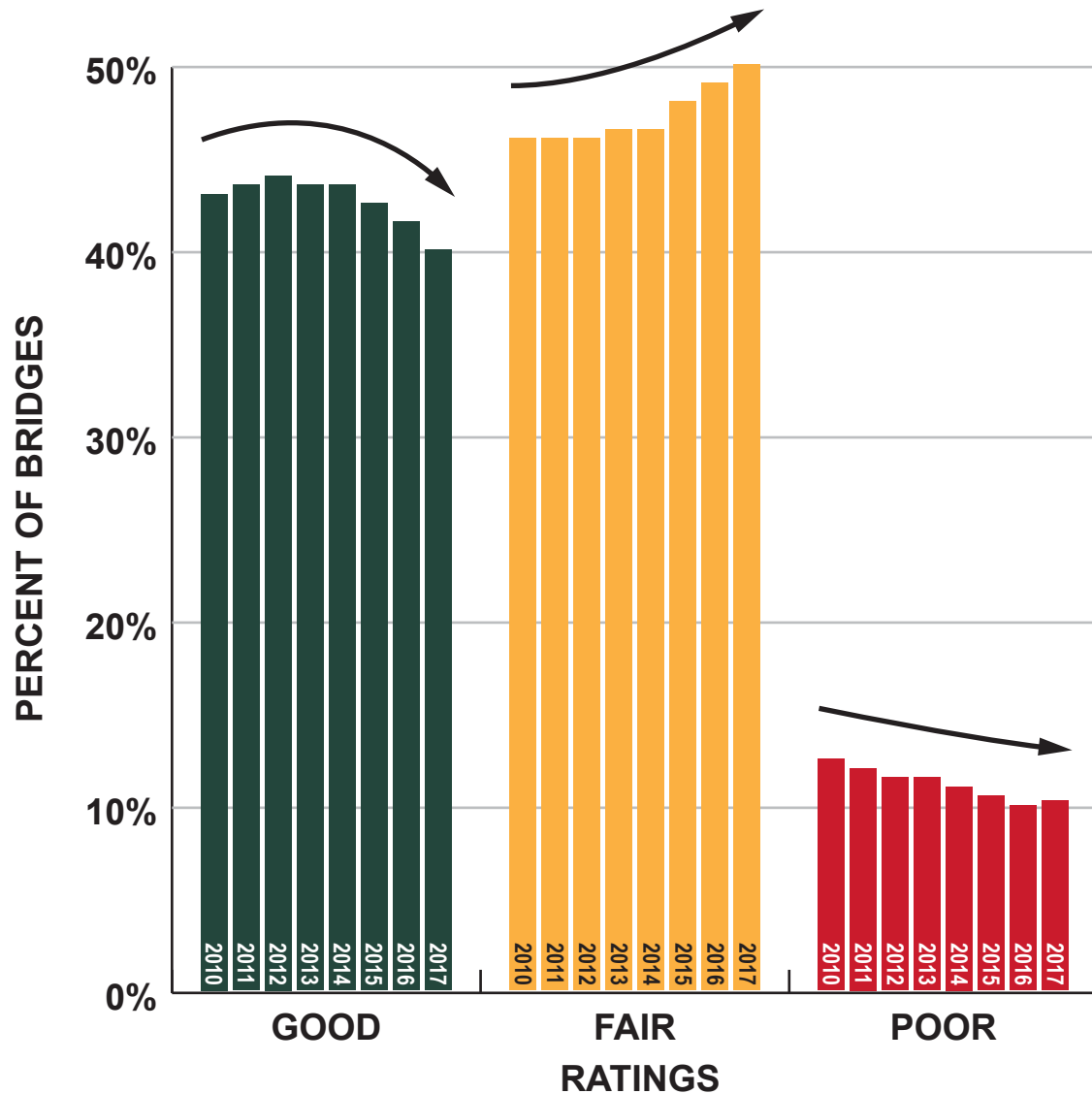

Figure 11

Source: MDOT 2010-17 Michigan Bridge Inventory

Figure 11 summarizes the percentage of Michigan bridges in good, fair, and poor condition for the years 2010-2017. Michigan bridge owners and decision makers have reduced the percentage of bridges in poor condition while increasing the number of bridges in good or fair condition. Although the trend-line for the poor category is decreasing, there is some concern that the trend for the good category is also decreasing at an increasing rate. Without continued implementation of effective preventive maintenance strategies and additional funding directed toward bridge maintenance, those fair to poor borderline bridges are in danger of dropping into the poor category.



Figure 12 shows that local bridge owners have maintained the number of poor bridges with progress only starting to reverse in 2017. The number of good bridges has decreased, and the number of fair bridges has increased. It is important that bridge-owning agencies apply strategic preventive maintenance strategies to maintain or reduce the number of bridges in fair condition (NBI Ratings of 5 or 6) to prevent them from dropping into the poor category (NBI Rating <5) where more expensive repairs are necessary.

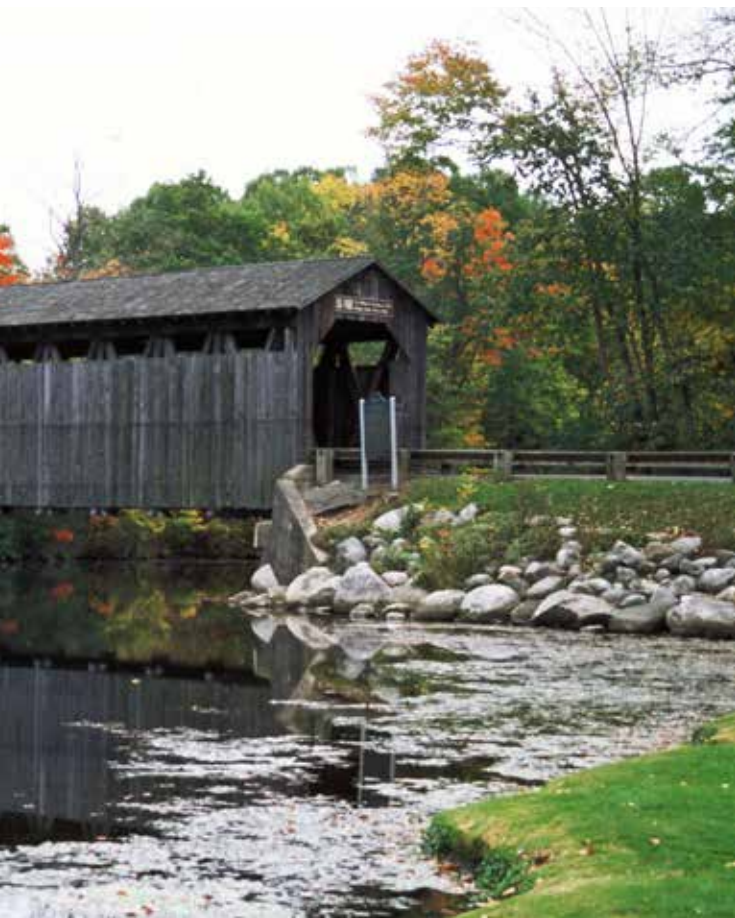

## 2014-2017 Local Bridge Condition Trend

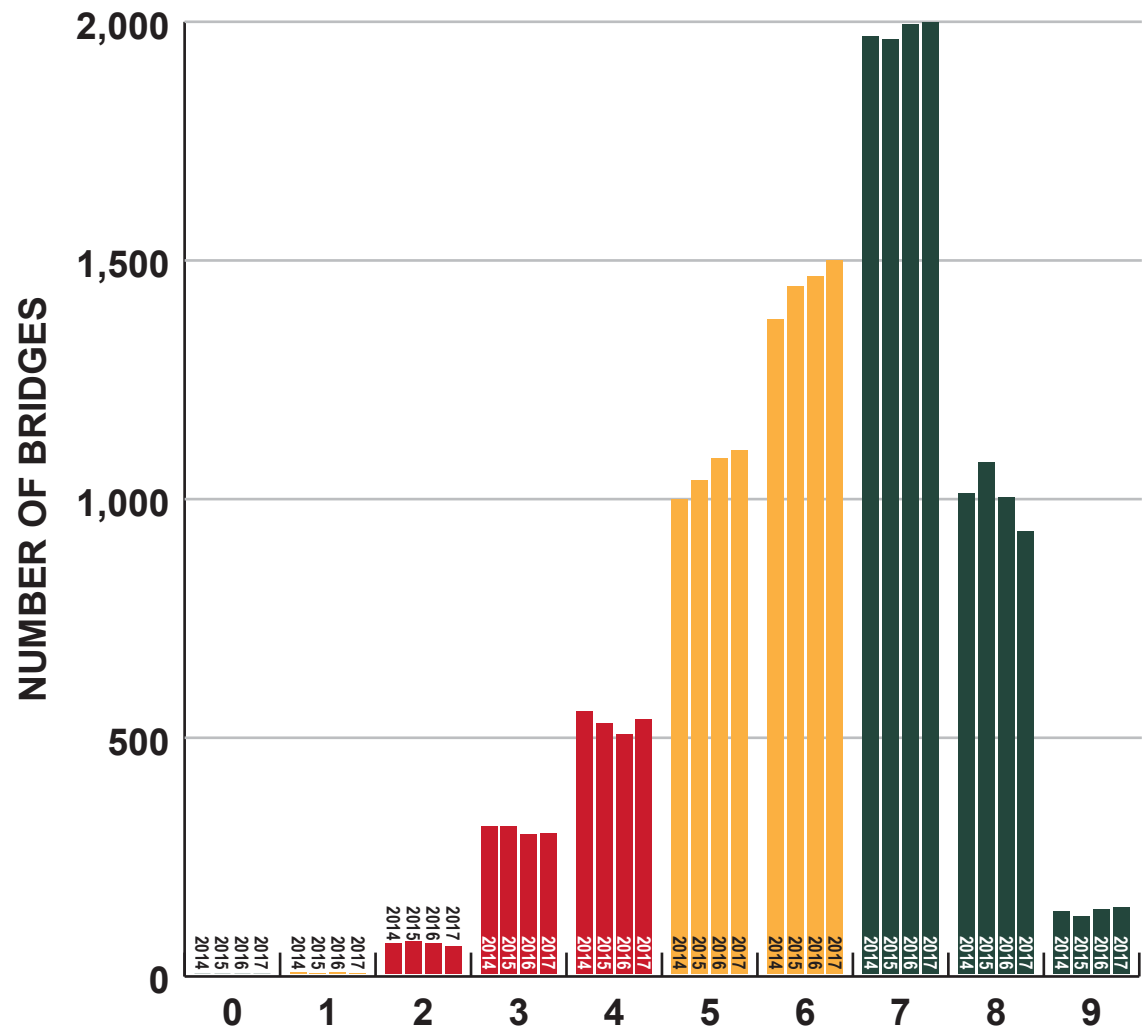

Figure 12

Source: MDOT, 2014-2017 Michigan Bridge Inventory

# 2014-2017 Trunkline Bridge Condition Trend

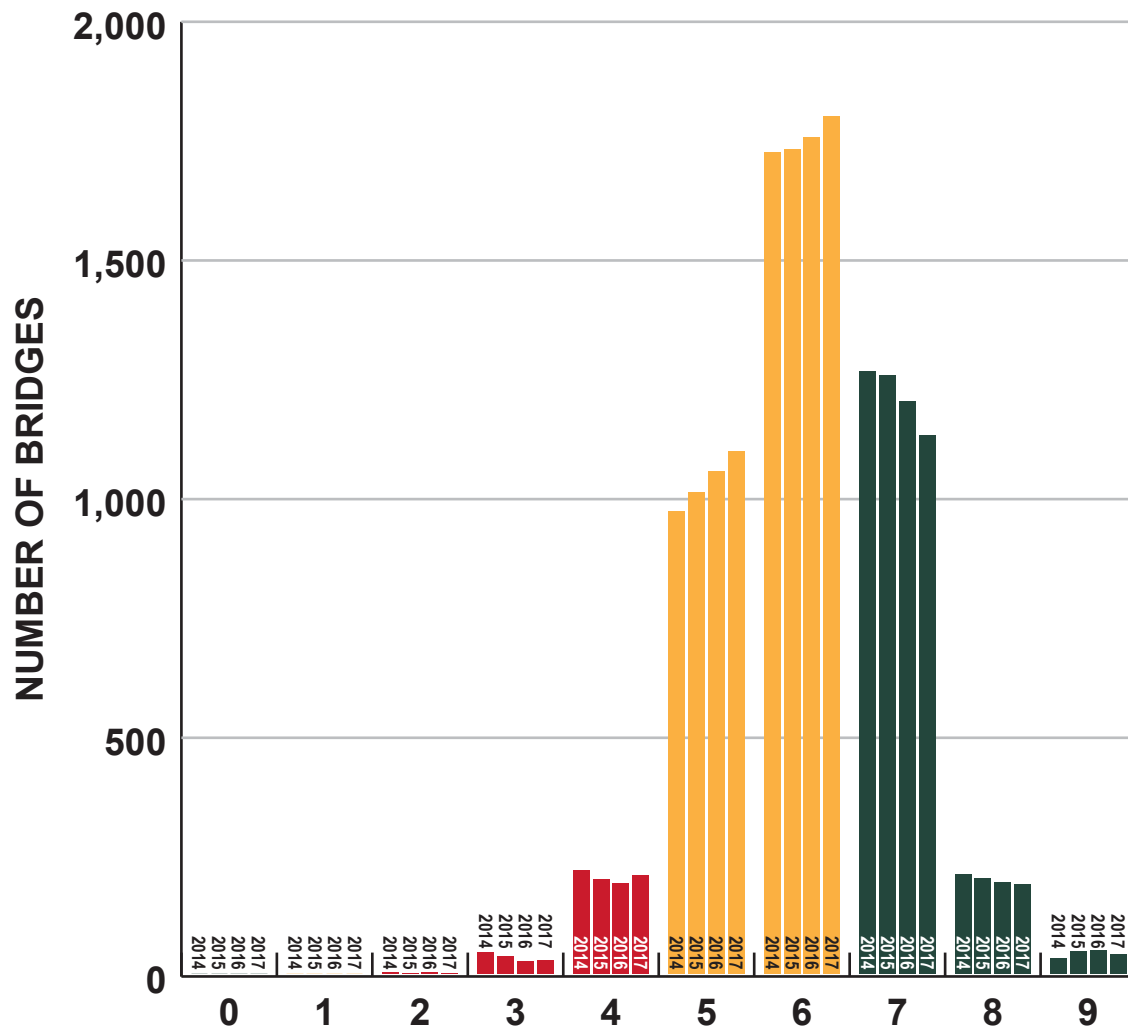

Figure 13

Source: MDOT, 2014-17 Michigan Bridge Inventory

Figure 13 shows that the MDOT's progress in reducing the number of poor bridges on state-owned roads has also slowed over the last four years. Until recently, MDOT has been able to maintain the number of fair bridges before they reach the poor category, while increasing the number of good and fair bridges. An aging infrastructure and rising costs have reversed some of that progress. The number of fair bridges has increased and in 2017 the number of poor bridges increased slightly as preservation needs exceed available revenues. Maintaining or improving the bridges rated in good or fair condition is imperative to prevent the number of bridges in the poor category from increasing further.





# Bridge Condition Forecast

Working from current bridge condition information (NBI Data), bridge deterioration rate, project costs, expected inflation, and fix strategies, the Bridge Condition Forecasting System (BCFS) estimates future condition of bridges. Figure 14 indicates the combined overall bridge condition of all the state's bridges is expected to decline after 2017. By 2025, nearly half of the progress made toward improving bridge condition since 2004 could be lost.

While additional highway funding was approved at both the state and federal level, no new funds were earmarked specifically for local bridge programs. Therefore, this forecast assumes no additional spending on bridges beyond those funds already designated for that purpose.



# 2018-2027 Bridge Condition Forecast

All Roadway Bridges (MDOT and Local Agency)

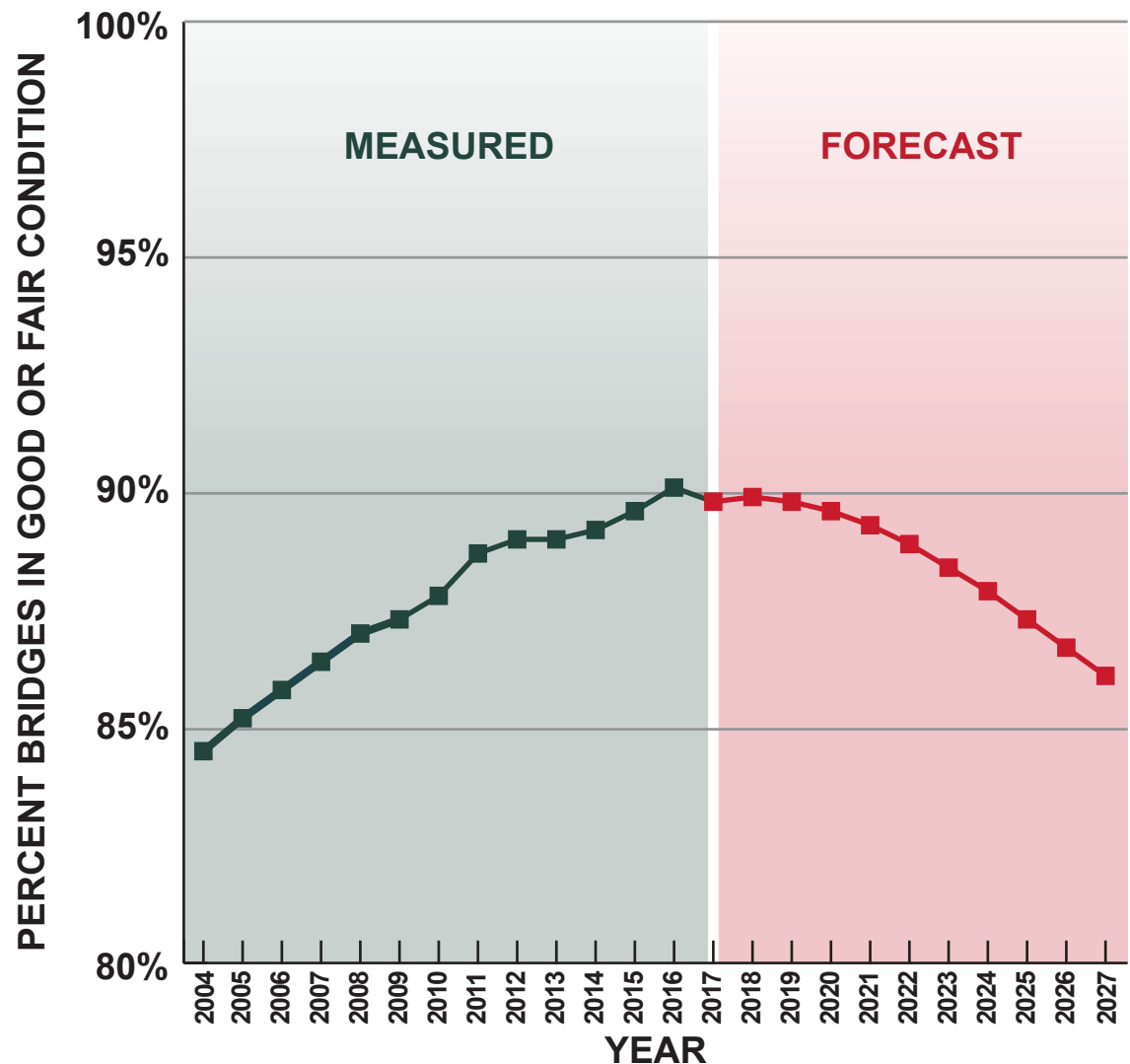
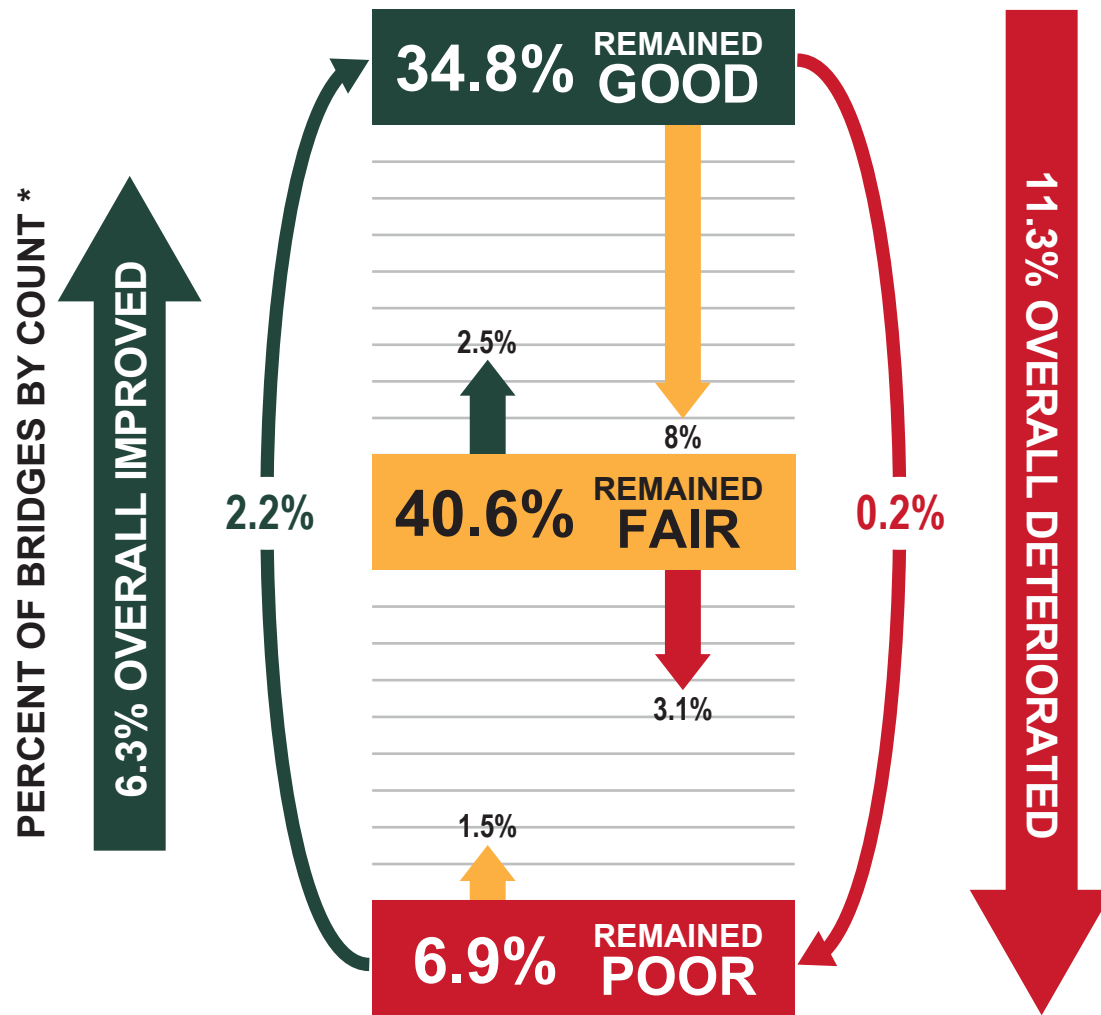

Figure 14  
Source: MDOT March 2018

# Michigan Bridges Cycle of Life

2014-2017



\* Does not include bridges added or removed in this time period

Figure 15

Source: MDOT March 2018

# Bridge Cycle of Life

Bridges, similar to roads, deteriorate through a cycle of life starting from good condition, to fair and ultimately to poor. There are many places where performing some Capital Preventive Maintenance (CPM) at a lower cost compared to a reconstruction or deck replacement can prolong the life of a bridge for many years.

Figure 15 shows the percentage of bridges that have improved or deteriorated into each of the major condition categories over the last four years (2014 – 2017). Michigan’s overall goal is to reduce the number of poor bridges, but unfortunately over this time span, 11.3 percent of Michigan’s bridges have worsened while only 6.3 percent of the bridges were improved.





# 2017 YEAR IN REVIEW



# TAMC Accomplishments

The TAMC in 2017 expanded on many of its ongoing efforts and made updating tools, increasing accessibility to data and continuing asset management education a priority. The council also made improvements to existing processes to strengthen and improve Michigan's statewide asset management approach. The council continues to work to improve awareness and understanding of asset management and its role in assessing and managing the roads and bridges in the state of Michigan.

## TAMC Investment

For the first time since it was created in 2003, the TAMC received an increase in its appropriated budget for FY 2018. The additional funding was requested to expand data collection to include unpaved roads (Inventory Based Rating (IBR)), expanded data collection on paved non-federal-aid eligible roads, and to assist road agencies in the preparation of Asset Management Plans. TAMC's annual budget increased from \$1,626,400 (FY2002 through 2017) to \$1,876,400 (FY2018).

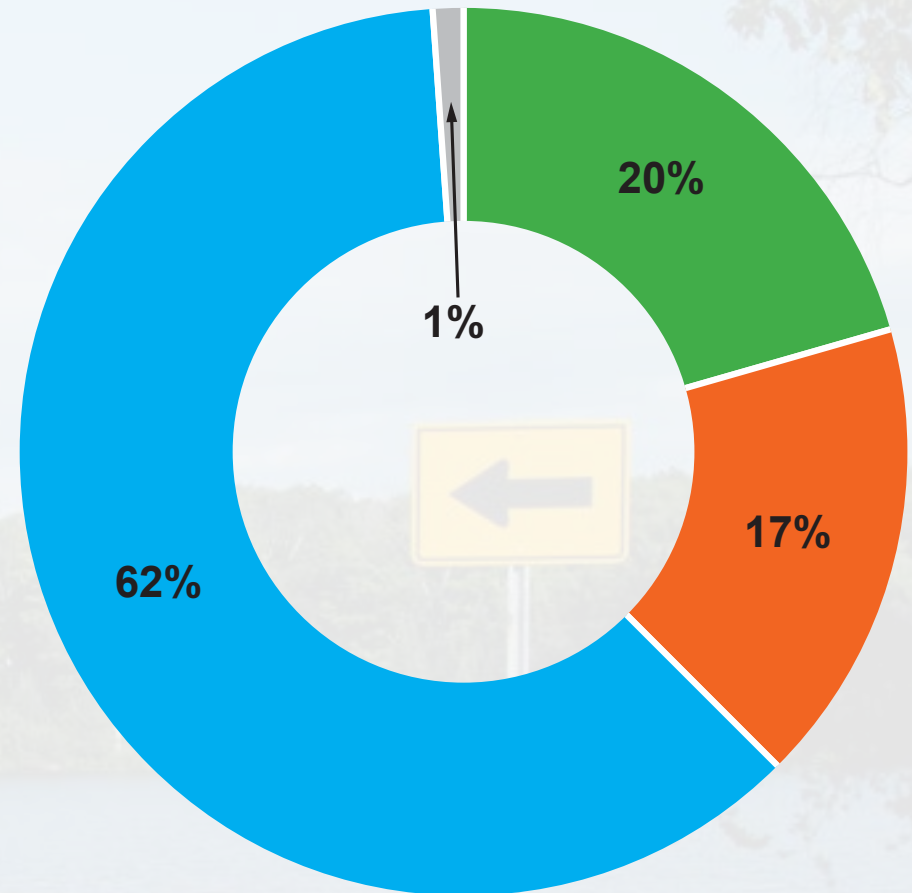

**FY2016 Budget Overview**

Regional Program and Data Collection	\$996,365
Central Data Agency, Technology and MTU	\$337,635
Training and Educational Activities	\$276,114
Council Expenses	\$16,286
Funding Source: Michigan Transportation Fund	<b>Total: \$1,626,400</b>

## Strengthening Partnerships

The TAMC worked through Michigan's Regional Planning Agencies and Metropolitan Planning Organizations (RPA and MPO) to coordinate with local agencies on staffing and logistics for pavement condition data collection and encourage participation. Once the local data was collected, RPA/MPOs reported these conditions to the TAMC. The communication and coordination of these tasks included ongoing formal and frequent informal interaction with MDOT staff, local agency staff and TAMC representatives working through partnering organizations such as the Michigan Transportation Planning Association (MTPA) and the Michigan Association of Regions (MAR). Support staff of TAMC held coordinating meetings

with RPA/MPO personnel throughout the year to ensure consistency among agencies.

## First Year of the TAMC Work Program

TAMC operates on a three year program of both ongoing and new activities designed to promote asset management practices and assist road-owning agencies in their asset management efforts. The TAMC participated in a strategic planning session in 2016 that included the development of the 2017-2019 TAMC Work Plan.

A copy of the current work plan can be found on our website at:

[https://www.michigan.gov/documents/tamc/TAMC\\_2017-2019\\_Work\\_Program\\_602136\\_7.pdf](https://www.michigan.gov/documents/tamc/TAMC_2017-2019_Work_Program_602136_7.pdf)



## New Data Collection Policies

This past year TAMC approved an updated Policy for Collection of Roadway Surface Condition Data. The policy includes both data collection for federal-aid eligible roads, and revised requirements for local agencies seeking reimbursement for data collection of data on non-federal-aid roads and unpaved roads. In 2017, local agencies collected pavement condition data for 55,645 lane miles of federal-aid eligible roads, as well 17,092 lane miles of non-federal-aid eligible roads.





## TAMC Conferences, Training and Education

TAMC sponsors two educational conferences to share information and review best practices on an annual basis. Both conferences were well attended and received positive feedback from the attendees. The Spring Conference in Mount Pleasant attracted 138 attendees and the Fall Conference in Marquette attracted 82 attendees.

In addition to the annual conferences, TAMC works with Michigan Technological University (MTU) to provide training for Data Collection and Asset Management. In 2017, 27 trainings were held, attracting 1050 participants. TAMC-sponsored trainings through MTU set a new record for attendance in 2017.

Training Program	Number of Training Events	Total Participants
PASER Training	10*	476
Asset Management for Elected Local Officials	7	191
Asset Management Workshop	2	40
Bridge Asset Management Workshop	3*	20
Inventory Based Rating (IBR) Training (Webinar)	2	133
Paved Asset Management Plan Workshop Pilot	1	19
Asset Management Conferences	2	171
<b>Total:</b>	<b>27</b>	<b>1050</b>

\* Not including webinars



### Investment Reporting Tool (IRT)

The IRT is the means by which agencies report to the TAMC on annual road and bridge investment projects. This past year the IRT had numerous updates and upgrades. According to local agencies one of the most helpful of these was a new landing page that provides agencies a summary of their project history and simplified several of the reporting requirements. The TAMC appreciates all the efforts and feedback by local agencies, council members, MDOT, MTU and DTMB in this major undertaking. The IRT was reviewed by the Michigan Infrastructure Asset Management Pilot Program as a potential model in obtaining information on assets beyond roads and

bridges. The Fall/Winter 2017 edition of MTU’s quarterly “The Bridge” featured the IRT and insight from local agencies to its role in compliance reporting and means to assist in managing their programs. To learn more on the IRT and see a summary of investment reporting please visit the Investment Reporting Section.

TAMC worked with the DTMB’s Center for Shared Solutions (CSS) to provide training for the IRT through onsite classes and webinars. In 2017, three webinars were held, as well as six on-site trainings at locations throughout the state, attracting a total of 88 participants in the first year this training was offered.

2017 IRT Training Summary	Participants
Total for On-site	57
Total Webinar	31
Total for 2017	88

### Michigan Infrastructure Asset Management Pilot Program

TAMC participated as a stakeholder in the Asset Management Pilot initiative. The work of the TAMC continues to serve as a model across infrastructure assets and further promote the importance of asset management across our State.



# TAMC Website, Interactive Map and Dashboards

## Website

In 2017, the TAMC recognized the need to provide a better means of sharing its different efforts and went through the process of updating its website. The new layout was intended to be more

intuitive to access all the different data efforts, trainings, meetings and policies. The majority of the webpages are now compatible with mobile devices like smartphones and tablets. Please check out

the new site at [www.michigan.gov/tamc](http://www.michigan.gov/tamc) and sign up for the Gov Delivery to stay abreast of any future updates. Click the graphics to hyperlink to the portion of the website depicted.

The screenshot displays the Michigan TAMC website interface. At the top, the navigation bar includes 'HOME', 'INTERACTIVE MAPS', 'REPORTING HUB', 'DASHBOARDS', and a search icon. Below this, a secondary menu lists 'CONFERENCE', 'TRAINING', 'SUPPORT', 'ABOUT US', and 'MEETINGS'. The main header features the Michigan.gov logo and the TAMC logo. A large banner image of a city street is overlaid with a dark box containing the text 'Preserving Roads & Bridges' and a sub-headline: 'The Michigan Transportation Asset Management Council (TAMC) - A resource for independent, objective data on the condition of Michigan's roads and bridges and a resource for implementing the concepts of Asset Management.' Below the banner are five service tiles: 'Interactive Maps' (Create an up-to-date road and bridge condition map), 'Reporting Hub' (Investment Reporting Tool (IRT), Act 51 Distribution and Reporting System (ADARS), Non-Trunkline Federal Aid (NTFA)), 'Dashboards' (Condition, operation, and investment in Michigan's public road system), 'Training' (Sponsored training, support, and education programs), and 'Council & Committee Meetings' (Meeting dates and approved minutes for the council). On the left side, a sidebar contains a 'Contact TAMC' section with a description of the council's composition and a 'How to subscribe to the ListServ' section with a 'JOIN THE TAMC MAILING LIST' button. A larger, semi-transparent version of this sidebar is overlaid on the top left of the main screenshot.

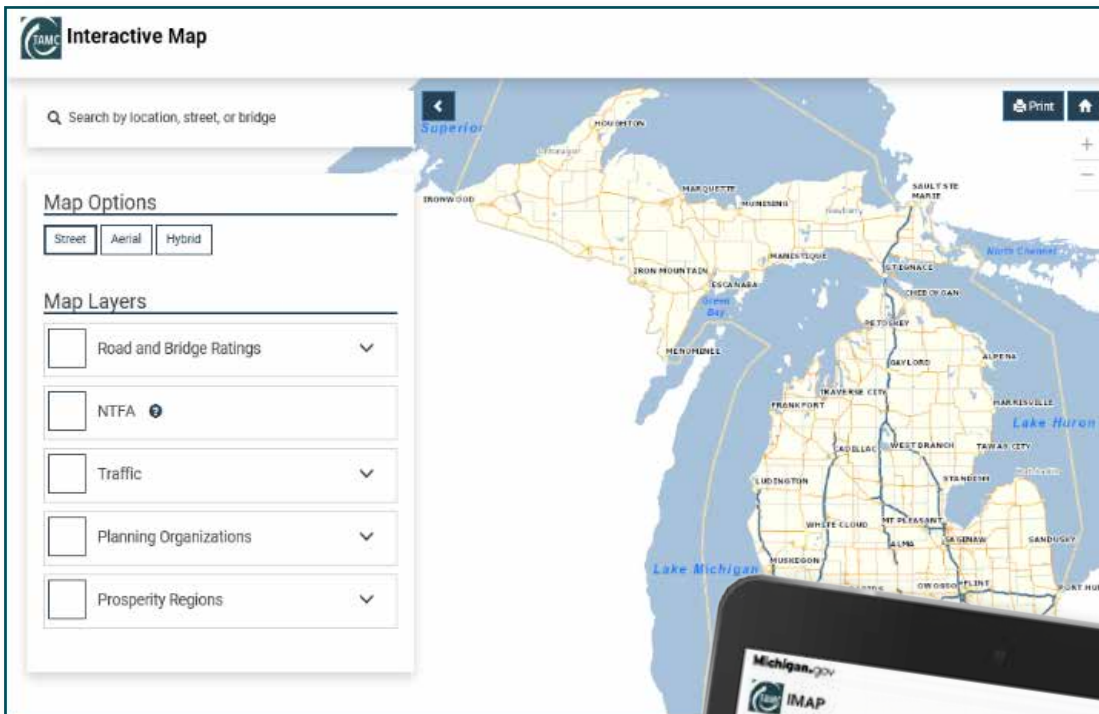

## Interactive Map

The TAMC maintains a public interactive map that includes historical and most current PASER condition ratings and most current National Bridge Inventory (NBI) bridge condition information. It also provides information on different traffic elements and locations of RPAs, MPOs and prosperity regions. The interactive map was also updated in 2017 and is now fully mobile and offers navigation and ease of use similar to Google maps or other commonly used websites.

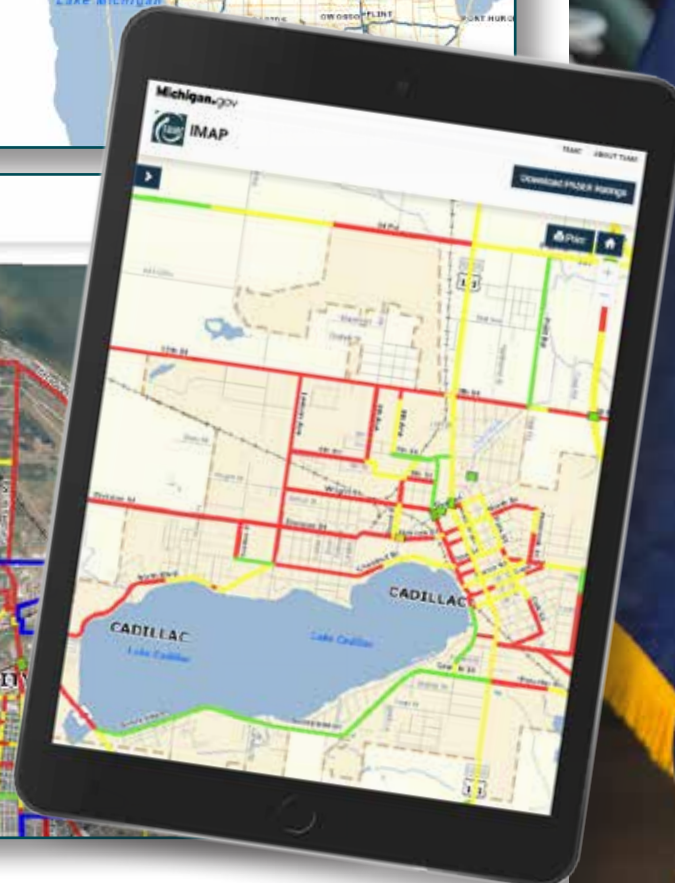
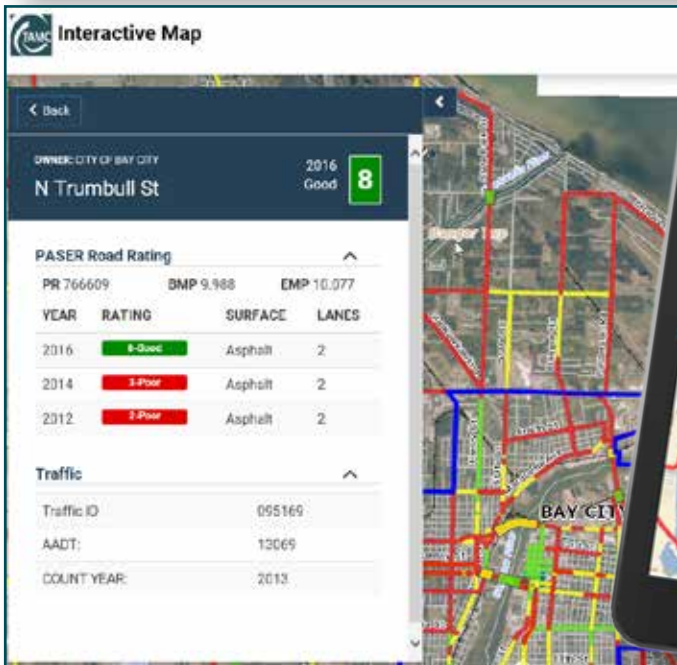

## Performance Measure Dashboards

The TAMC has developed and improved upon several Performance Measure Dashboards that show the condition, operation, and investment in Michigan's public road and bridge system. These dashboards are slated to be raised to a new technology in 2018, so the layouts and navigation will be improved and supported by mobile technology similar to the IRT and Interactive Map. Click on each graphic below for hyperlink to the Performance Measure Dashboards.

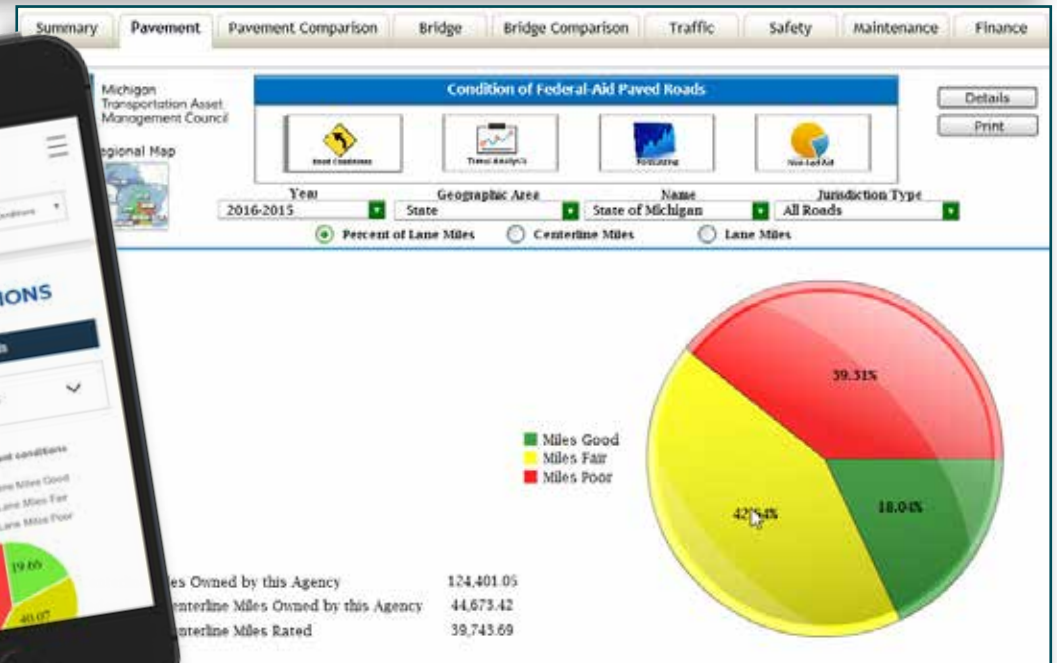
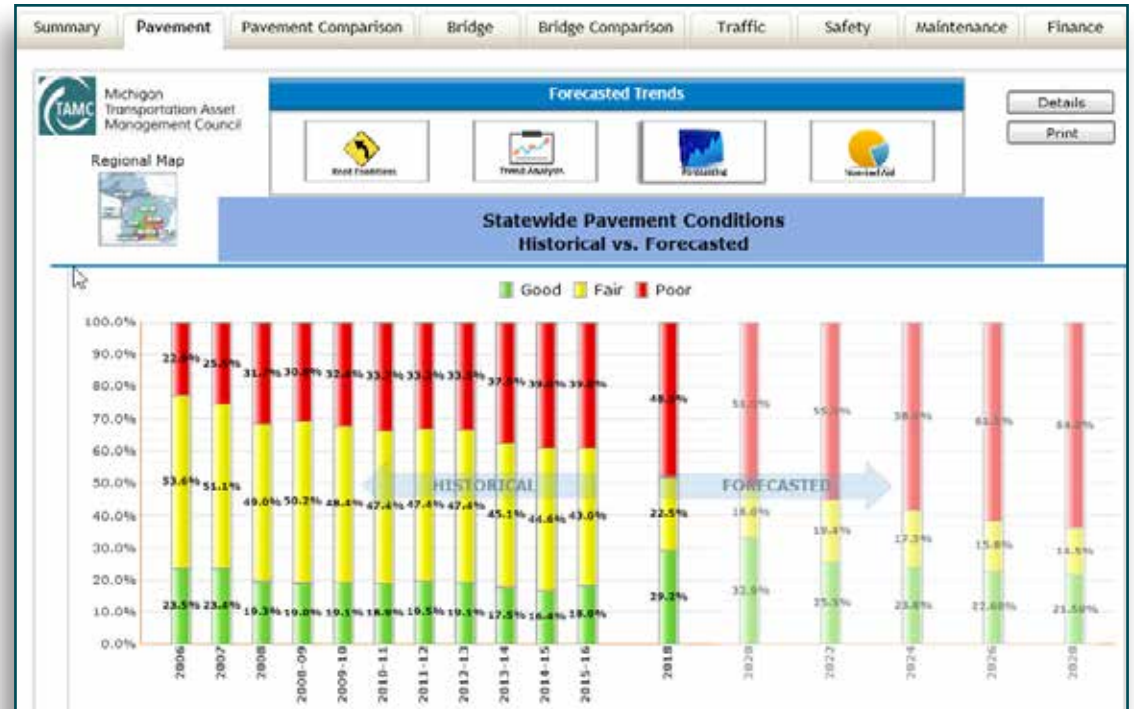



## Pavement Condition and Comparison Dashboards

These two dashboards are based on PASER ratings for all paved federal-aid eligible roads in the state. This includes all state trunklines as well as roads under the jurisdiction of Michigan's counties, cities and villages.

These dashboards illustrate both the current pavement condition and the trend over the past 8 years. The Pavement Comparison Dashboard provides the user with the ability to compare recent system performance for up to eight road owning agencies at one time.

## Bridge Condition and Comparison Dashboards

Bridge conditions are based on bi-annual inspections of over 10,000 state, county, city and village owned bridges. These two dashboards illustrate bridge conditions and trends and provides the user with the ability to compare system performance for up to 8 bridge-owning agencies at one time.



## Traffic Dashboard

Traffic volumes are a measure of both road use and how effectively the road system is performing. This dashboard shows estimated annual miles of travel on Michigan's public roads by type and owner of road used, as well as a comparison of the relative sizes (in centerline miles) of portions of Michigan's road network.

## Safety Dashboard

The rate of crashes (fatalities, serious injuries) is a measure of how effectively the road system is performing in safety.

## Maintenance Dashboard

This dashboard provides a county by county comparison of winter maintenance expenses that are necessary to keep roads and bridges performing during winter maintenance operations.

## Finance Dashboard

Capital investments are necessary to extend the useful life of any asset including roads and bridges. This dashboard illustrates how Michigan's road-owning agencies are investing Michigan Transportation Fund aid into the roads and bridges they own, and the revenues received annually by each agency.

All agencies may freely link to these dashboards to provide transparency rather than creating their own. Act 51 requires that each county road agency maintain a searchable website that includes a financial-performance dashboard with information on revenues, expenditures and unfunded liabilities. Adding a link to the TAMC website meets those requirements.

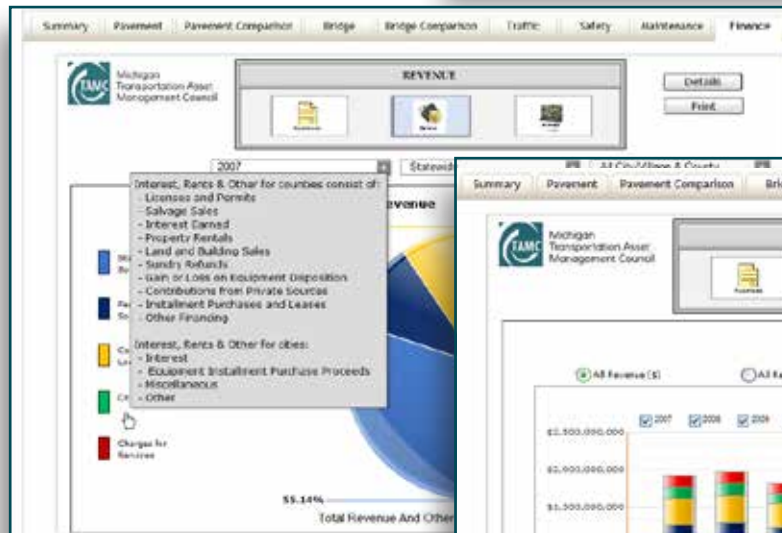
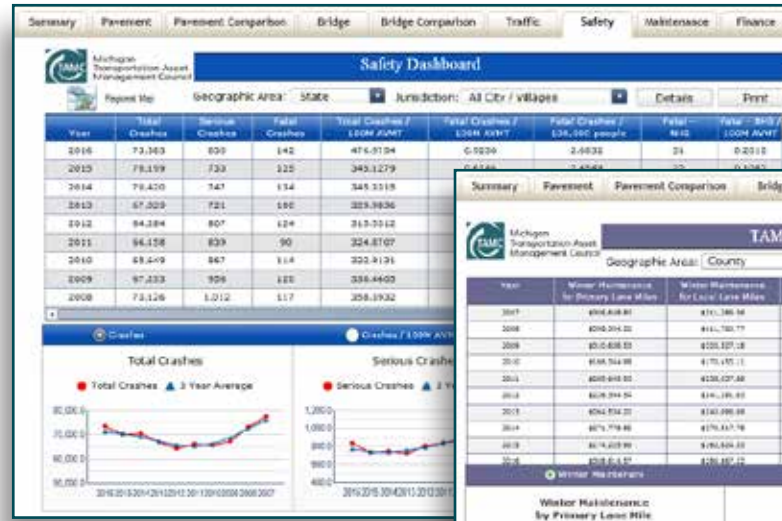

# INVESTMENT REPORTING

14 FT. 5 IN.



The IRT was developed by the TAMC to allow all Michigan road agencies to satisfy the requirements of Act 51. The basic requirements are that road-owning agencies report on projects they have completed and projects which are planned in the next three years. Since its initial inception the IRT has been refined and updated, reflecting customer feedback. In October 2014 the reporting requirements were made mandatory and are based on an agency's fiscal year end date. Currently there are over 1,000 registered IRT users. The TAMC provides training and a help desk to assist agencies in satisfying this reporting requirement.

The IRT offers an initial summary of an agency's entered projects and status of its compliance reporting. One of the main features of the IRT is a map view that shows the location of road projects reported for the road agency. Recent upgrades to the IRT allow agencies to print customized maps and reports specific to their respective agency. Both completed and planned projects can be displayed or included in newly-designed reports.

The IRT was upgraded several times in 2017. Project data can be entered graphically or in tabular format. A survey of asset management information has also been included. This allows agencies to voluntarily submit written asset management plans and describe the asset management process they use. A summary of the survey responses follows in a later section.

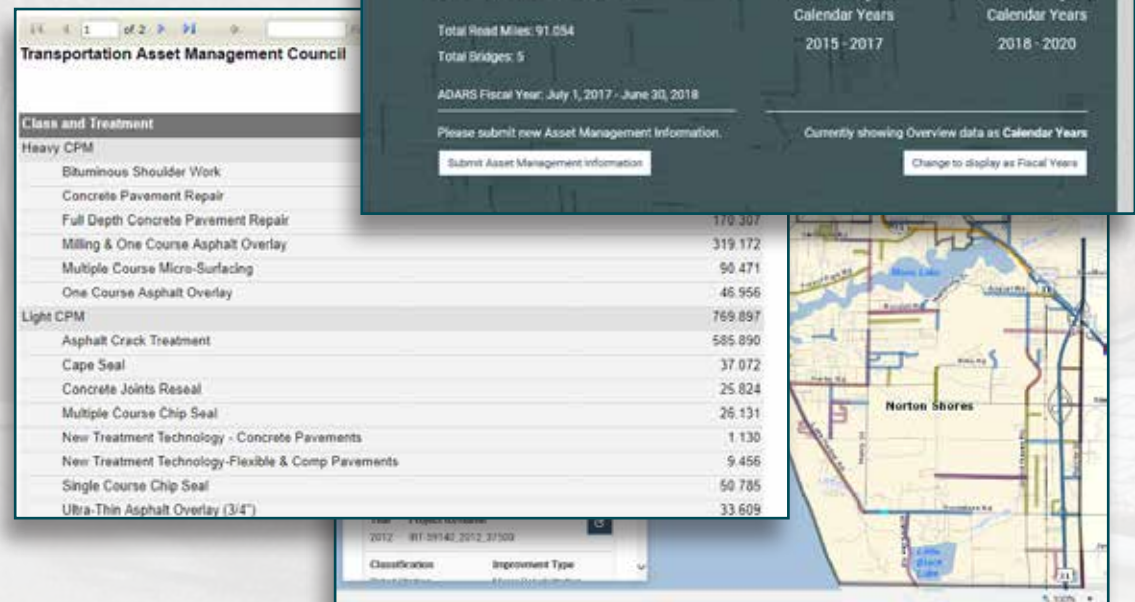

Note: The IRT is only accessed by agencies, and not the public.

# Act 51 Compliance Reporting

The IRT has been linked to Michigan’s Act 51 Distribution and Reporting System (ADARS). Both IRT data and ADARS data must be submitted within 120 days of an agency’s fiscal year end date. This linkage helps to ensure compliance. However, this does pose some reporting challenges at the statewide level as project data is received throughout the year versus a common annual deadline.

Because of the effective date of mandatory compliance, 2016 is the first complete year of road and bridge project investment data reporting. Data for calendar year 2016 includes projects submitted by more than 600 agencies and includes over 12,000 miles of road projects and nearly 300 bridge projects. The total investment reported exceeds \$1.7 billion dollars.

Data for 2017 projects is currently being submitted. As of April 2018, over 4000 road and bridge projects with a cost of \$1.1 billion have been received by the TAMC. In addition, over 2,200 miles of planned projects have been entered by local agencies for FY2018-2020.



## Road Projects Details

Agencies are required to report road projects based on 4 project work types. The work types are 1) Light Capital Preventive Maintenance (Light CPM), 2) Heavy CPM,

3) Rehabilitation, and 4) Reconstruction. The following table presents the number of projects, level of investment and miles of projects by these work types.

2016 Road Projects Details			
Type of Projects	Count	Cost	Lane Miles
Light CPM	613	\$36,097,856	2416
Heavy CPM	1940	\$269,179,076	5905
Rehabilitation	1410	\$446,812,298	2664
Reconstruction	597	\$702,797,690	1058
<b>Total Number of Road Projects:</b>	<b>4560</b>	<b>\$1,454,886,920</b>	<b>12043</b>



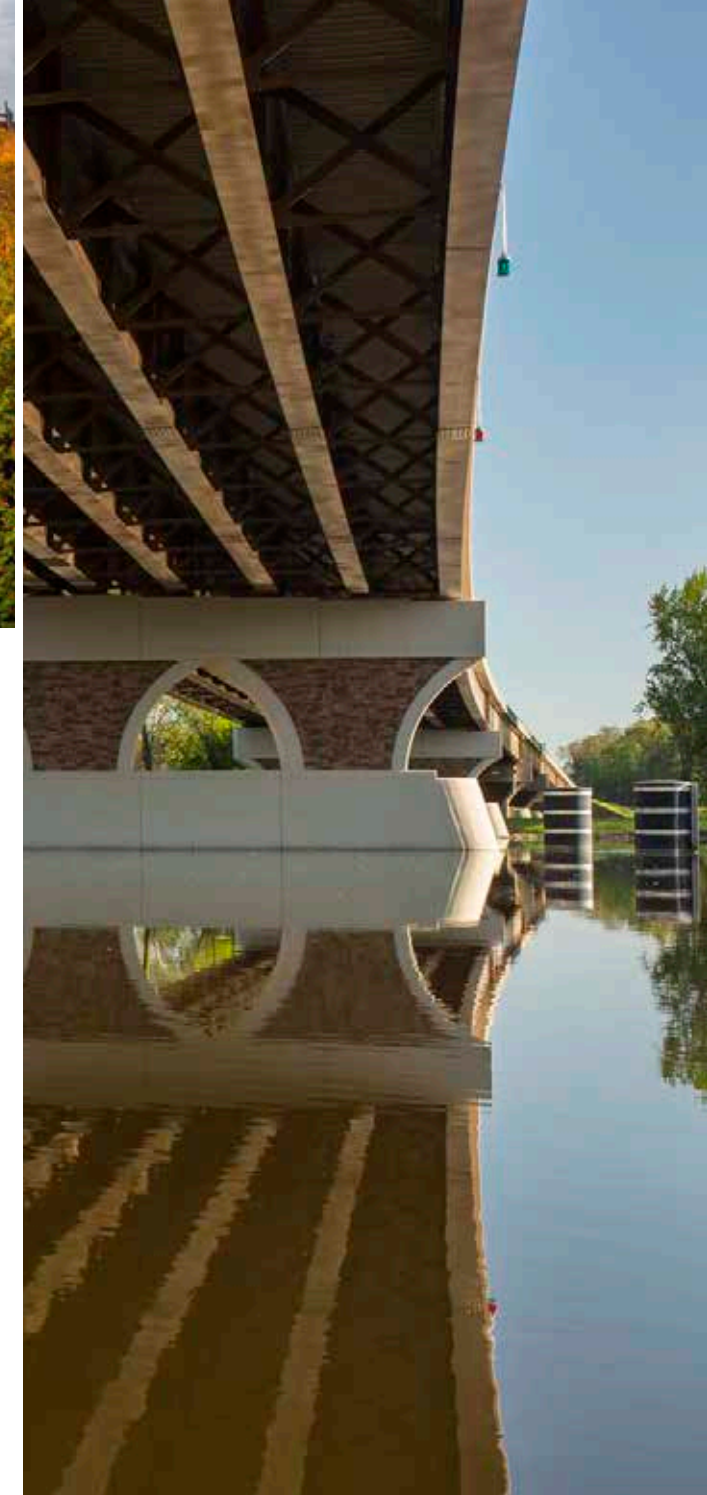

## Bridge Projects Details

Bridge projects are reported based on 5 project work types. The work types are 1) CPM, 2) Scheduled Maintenance, 3) Structural Improvement,

4) Rehabilitation, 5) Replacement. The following table presents the number bridge projects and level of investment by the 5 work types.

2016 Bridge Projects Details		
Type of Projects	Count	Cost
Capital Preventive Maintenance	100	\$26,204,893
Scheduled Maintenance	28	\$7,687,249
Rehabilitation	68	\$46,060,926
Replacement	91	\$224,198,731
Structural Improvement	7	\$25,186,536
<b>Total Number of Bridge Projects:</b>	<b>294</b>	<b>\$329,338,335</b>

# 2016 Reported Preliminary Statewide Percent of Projects

by Lane Miles of Road Projects

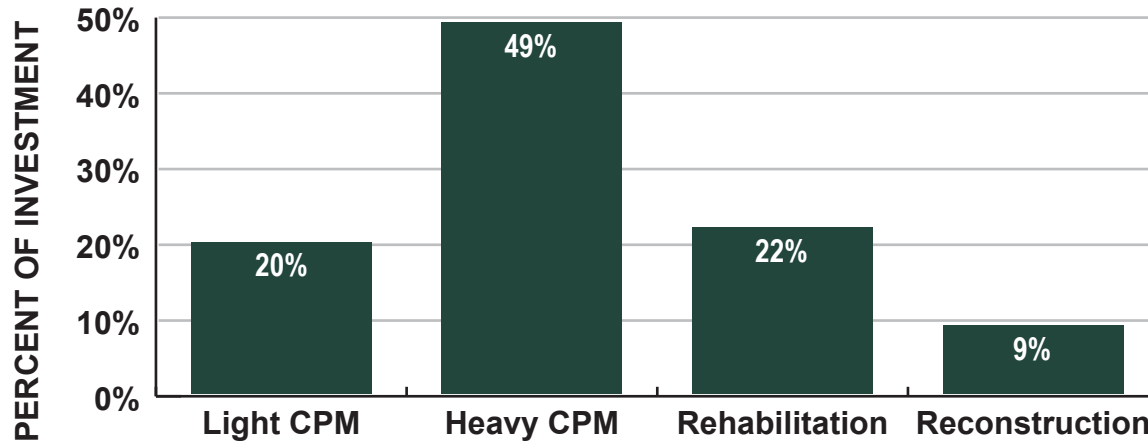

# 2016 Reported Preliminary Statewide Percent of Investment

by Project Classification of Road Projects

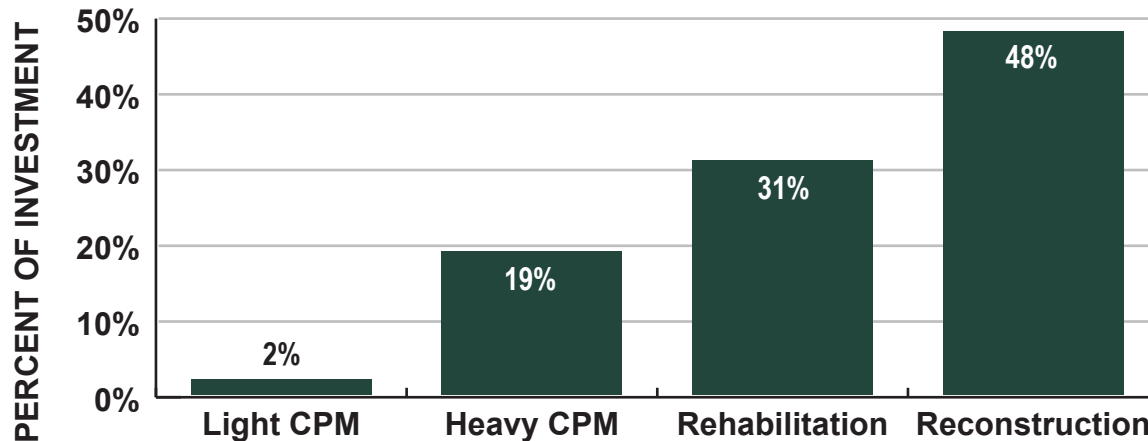

# Preliminary Analysis: Defining a Statewide Asset Management Strategy

These tables are examples of the initial ongoing analysis of data reported in the IRT. The tables reflect the statewide strategy for investing in the public road system. Reconstruction type projects account for 48% of the investment and 9% of projects while light CPM accounts for 2% of the investment but 20% of reported projects. A term commonly used in asset management is “mix of fixes.” The tables reflect the mix of fixes applied by over 600 agencies.



# Saving the 5's

A PASER rating of 5 is generally considered the point in a pavement life cycle where lower cost improvements such as heavy CPM and rehabilitation prevent deterioration, which would lead to much more expensive reconstruction. This strategy is sometimes called saving the 5's. The table below reflects the type of projects applied to roads rated 5 in 2015 and 2016.

Breakdown of Road Projects Applied to PASER 5	
Light CPM	40%
Heavy CPM	38%
Rehabilitation	14%
Reconstruction	8%



## Asset Management Plans and Process Survey

One of the new items in the 2017 IRT 2.0 was the addition of an asset management survey tool. The intent of this effort was to gather further background on how agencies manage their road and bridge assets. Agencies are given the option to also upload an asset management plan or documents that have assisted in their asset management process. Below are the number of agencies responding positively to these questions.

IRT Asset Management Survey Questions and Responses	
1. Does your agency have a written Asset Management Plan?	133
2. Does your agency use an asset management process?	252
3. Does your agency have separate plans or condition goals for the Primary Road/Major Street versus the Local Road / Street networks?	200
4. Does your agency use pavement management software or tools to identify and prioritize future road projects?	193
5. Does your agency use a variety of preventive maintenance and rehabilitation treatments for roads?	343
6. Does your agency plan road projects 3 or more years in advance?	261

Note: Question 1 is the only question requiring a response



## Regional Planning Agencies

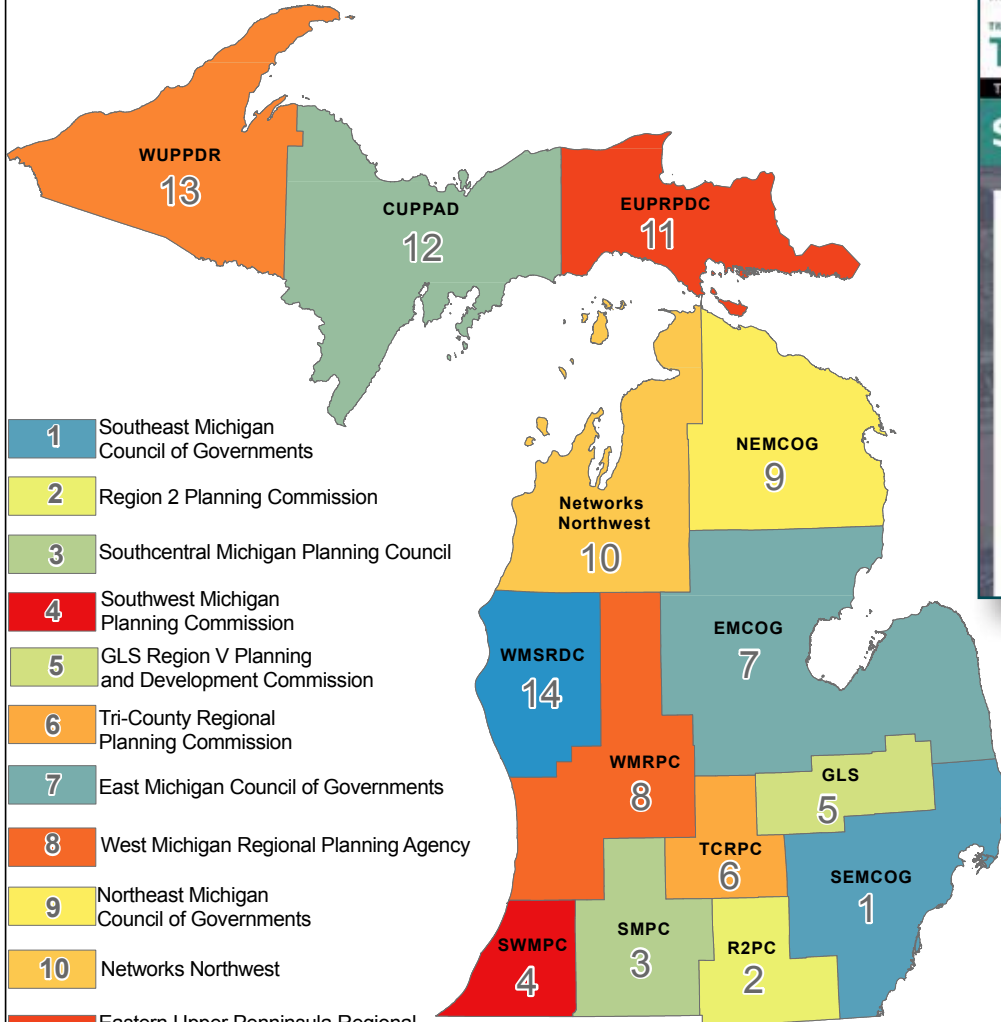

- 1 Southeast Michigan Council of Governments
- 2 Region 2 Planning Commission
- 3 Southcentral Michigan Planning Council
- 4 Southwest Michigan Planning Commission
- 5 GLS Region V Planning and Development Commission
- 6 Tri-County Regional Planning Commission
- 7 East Michigan Council of Governments
- 8 West Michigan Regional Planning Agency
- 9 Northeast Michigan Council of Governments
- 10 Networks Northwest
- 11 Eastern Upper Peninsula Regional Planning and Development Commission
- 12 Central Upper Peninsula Planning and Development Regional Commission
- 13 Western Upper Peninsula Planning and Development Region
- 14 West Michigan Shoreline Regional Development Commission

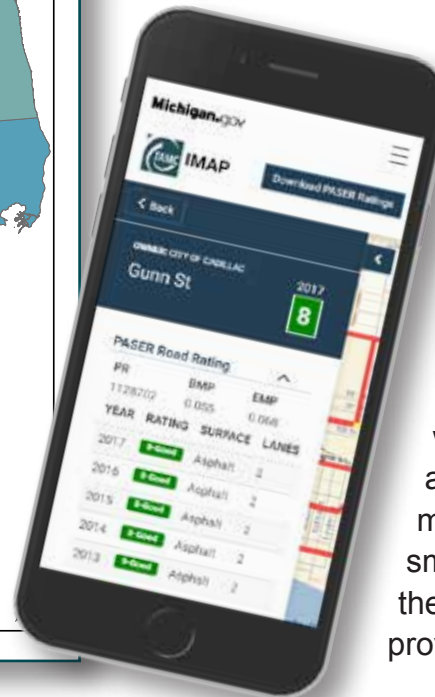
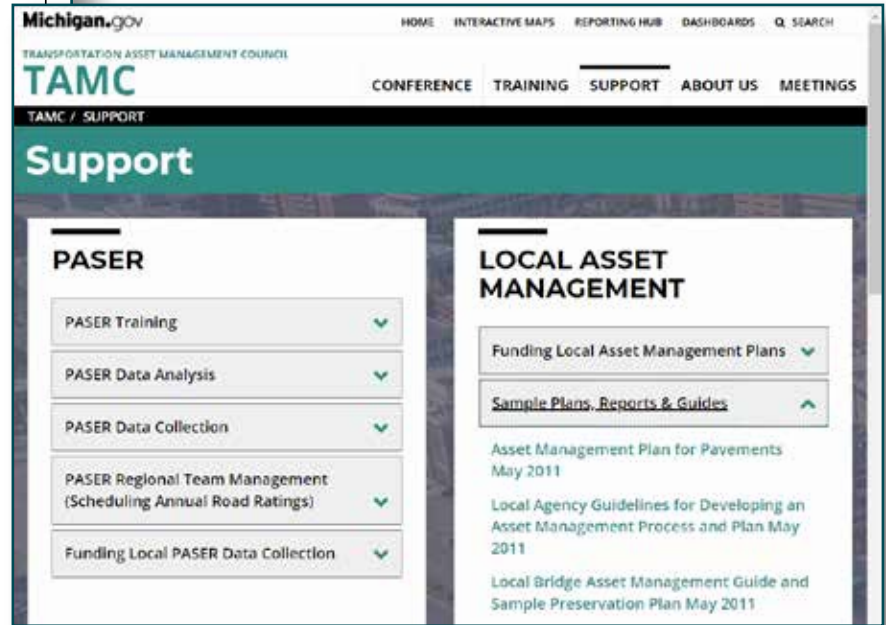

## Planning Agency Involvement

Regional and Metropolitan Planning agencies have been authorized to assist local agencies in complying with reporting requirements and preparation of asset management plans. Many smaller agencies have expressed their appreciation for the help provided by their RPA or MPO.



# LOOKING INTO 2018



## Michigan Infrastructure Asset Management Pilot Program

In April, the participants in the Michigan Infrastructure Asset Management Pilot Program will provide a report to the Michigan State Legislature on the results of their effort. The report's recommendations could impact the TAMC and asset management statewide as it works to bring a more structured asset management approach to infrastructure assets beyond transportation.

### 21st Century Infrastructure Commission Asset Mana

All Data Classes Received by Pilot

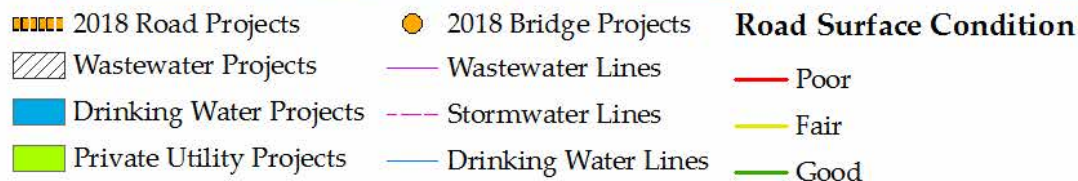
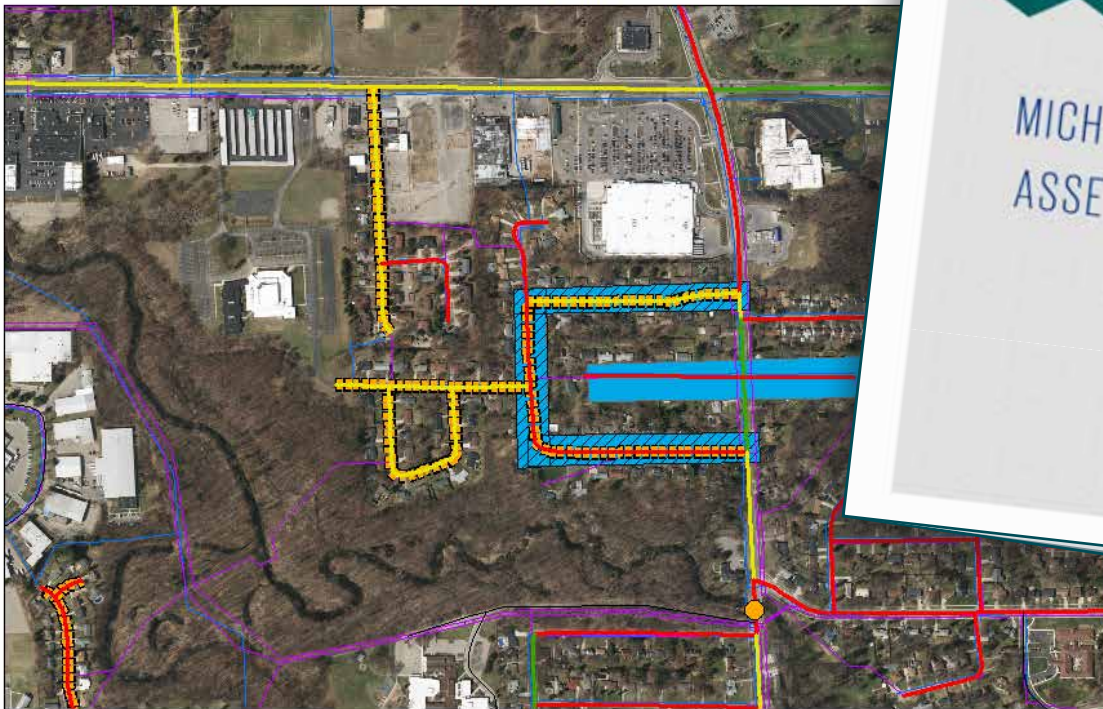

## Culvert Pilot Project

The Michigan Legislature provided two million dollars to the TAMC for a pilot effort to inventory and inspect cross road culverts. Some of the planned outcomes are to develop a rating system, provide training, estimate the amount of effort and cost to implement more broadly, with a summary report due in the Fall of 2018. In response to a survey conducted by the TAMC as part of the project, a number of agencies indicated a willingness to participate, as shown on the map below.

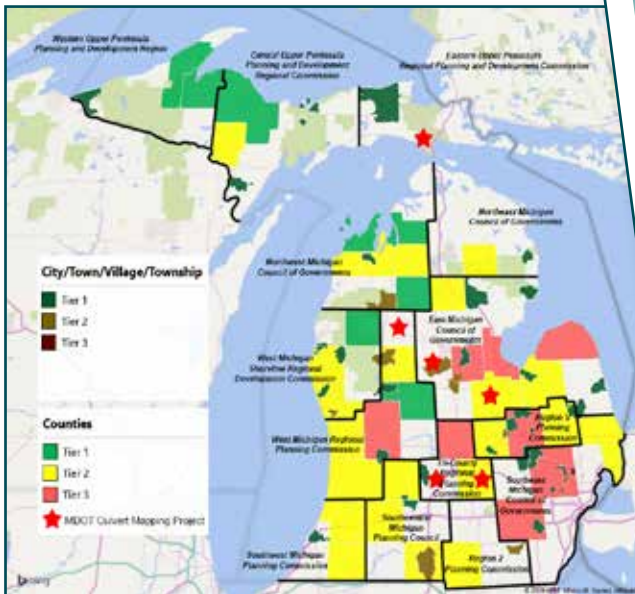

## Joint Conference

For its 2018 Spring Conference, TAMC has coordinated its efforts with the Michigan Chapter of the American Public Works Association (APWA). The two groups will be hosting conferences co-located at the Grand Traverse Resort. TAMC welcomes the opportunity to partner with APWA to share information about asset management efforts with a broader audience.

**2018 Transportation Asset Management Conference**  
Sharing the Experience:  
Uniting Michigan with Asset Management

**May 22, 2018**  
**SPRING CONFERENCE**  
Grand Traverse Resort and Spa  
Traverse City, MI  
8:00 a.m. - 4:00 p.m.

**TAMC** Michigan Transportation Asset Management Council  
**APWA** AMERICAN PUBLIC WORKS ASSOCIATION  
Your Competitive Public Works Resource

[www.michigan.gov/tamc](http://www.michigan.gov/tamc)

## Transparency and Collaboration

TAMC plans to share information on road and bridge projects from the IRT with the public via the Interactive Map. This change will help further collaboration, transparency and public awareness. This will also provide additional opportunities to coordinate improvements to infrastructure assets that share the road right-of-way.

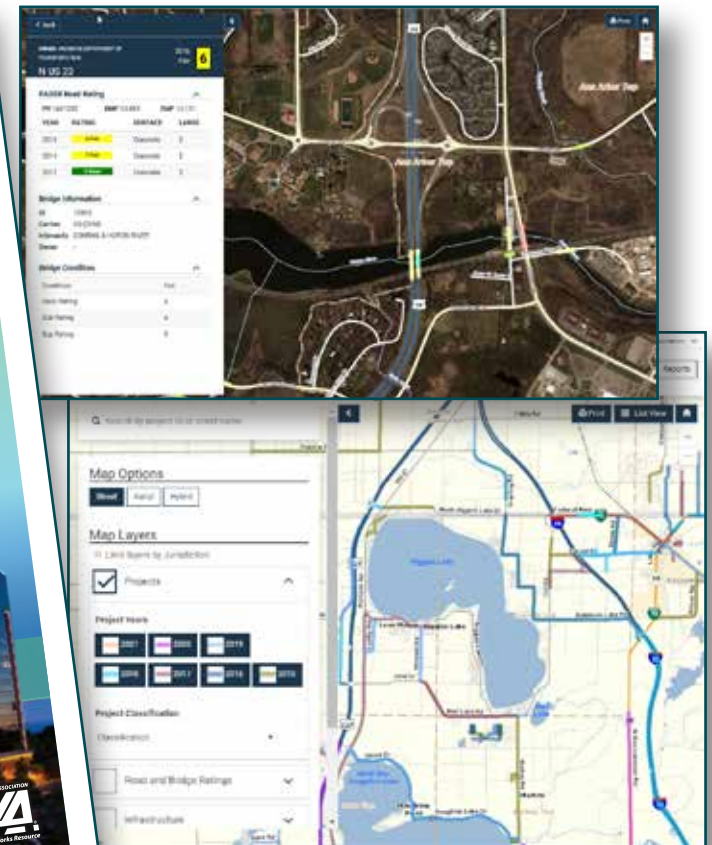



## Improving Technology

Improvements to several key TAMC products and services are planned in 2018. The Performance Metrics Dashboards will become fully mobile and integrated. PASER data collection at the regional level will provide feedback, quality control and timelines for data submittal. The IRT will be updated with advanced regional reports, the ability to customize improvement types, and ADARS cost indicators, as well as other user suggestions.

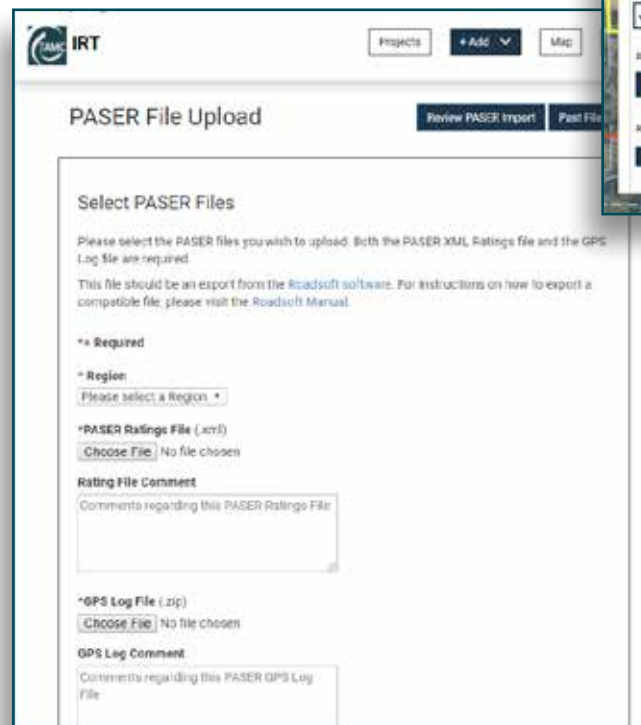

The screenshot shows the 'PASER File Upload' interface. At the top, there are buttons for 'Projects', '+ Add', and 'Map'. Below this, there are buttons for 'Review PASER Import' and 'Paste File'. The main section is titled 'Select PASER Files' and contains instructions: 'Please select the PASER files you wish to upload. Both the PASER XML Ratings file and the GPS Log file are required. This file should be an export from the Roadsoft software. For instructions on how to export a compatible file, please visit the Roadsoft Manual.' There are three main sections for file selection: 1. '\* Required Region: Please select a region.' with a dropdown menu. 2. '\* PASER Ratings File (.xml): Choose File | No file chosen'. 3. '\* GPS Log File (.zip): Choose File | No file chosen'. Each section has a corresponding text area for 'Rating File Comment' and 'GPS Log Comment'.

## IRT Analysis

With a complete year of 2016 data gathered, and 2017 data now becoming available, additional analysis of IRT projects, costs, and condition data can be investigated.

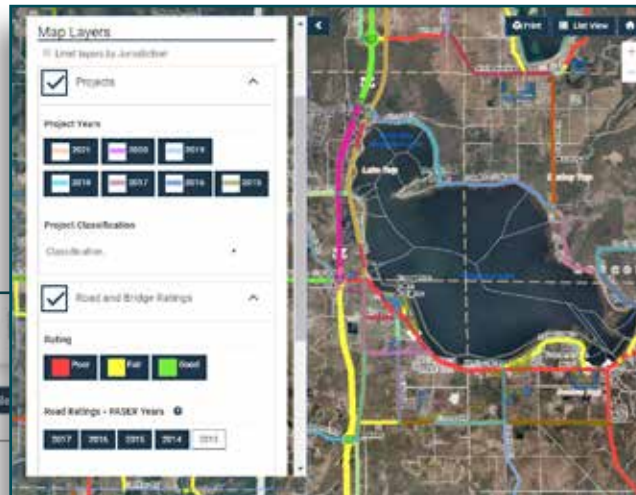

## Inventory Based Rating of Gravel Roads

2018 will be the first full year that will include training and data collection on the condition of gravel roads using the Inventory Based Rating (IBR) system. This will be similar in many ways to the PASER process that is used for rating paved roads.



# ACRONYMS AND ABBREVIATIONS

**Any reference to Act 51 in this document refers to Public Act 51 of 1951, as amended.**

ADARS: Act-51 Distribution and Reporting System

BCFS: Bridge Condition Forecasting System

CPM: Capital Preventive Maintenance

CRA: County Road Association (of Michigan)

CSS: Center for Shared Solutions (DTMB)

CTT: Center for Training and Technology (MTU)

DTMB: Department of Technology, Management and Budget

FHWA: Federal Highway Administration

FAST: Fixing America's Surface Transportation Act

IBR: Inventory Based Rating

MAC: Michigan Association of Counties

MAR: Michigan Association of Regions

MDNR: Michigan Department of Natural Resources

MDOT: Michigan Department of Transportation

MML: Michigan Municipal League

MPO: Metropolitan Planning Organization

MTA: Michigan Township Association

MTPA: Michigan Transportation Planning Association

MTU: Michigan Technological University

NBI: National Bridge Inventory

NFC: National Functional Classification

NHS: National Highway System

PASER: Pavement Surface Evaluation and Rating

RPA: Regional Planning Agency

STP: State Transportation Program

TAMC: Transportation Asset Management Council



# **“All public roads in Michigan will be managed using the principles of asset management”**

**- Public Act (PA) 499 of 2002 created the TAMC**

**[www.michigan.gov/tamc](http://www.michigan.gov/tamc)**

